

Unsere Europäischen Kunden

Our European Customers

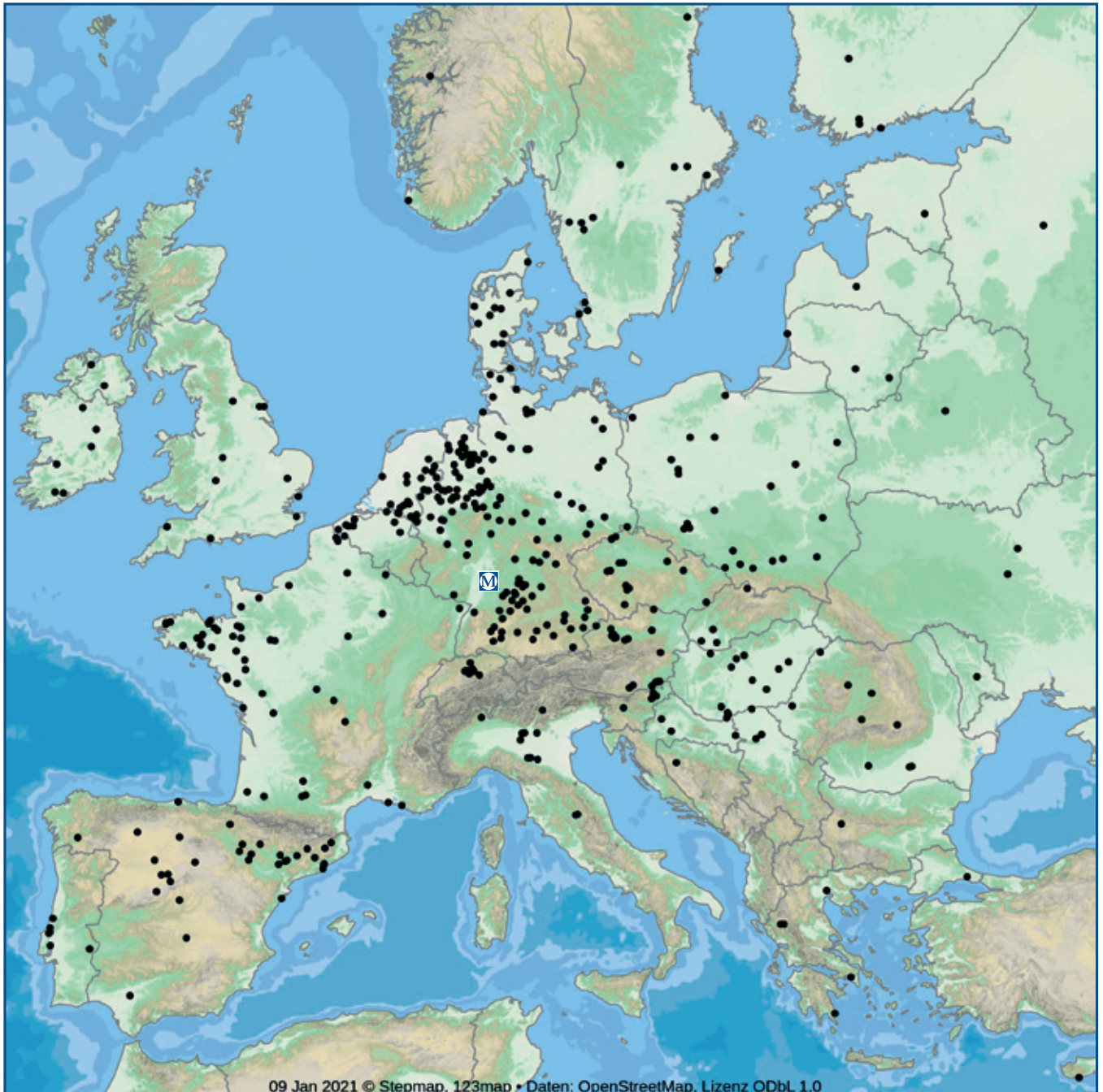

PRODUKTKATALOG PRODUCT CATALOG



Kontaktgitter

Edelstahl, mit runden Trennstäbe Ø 16 mm, inkl. Befestigungsmaterial Innenmaß: 1020 mm x 375 mm

Contact gate

stainless steel, with round dividers Ø 16 mm, incl. fasteners for installation Inner dimension: 1020 mm x 375 mm

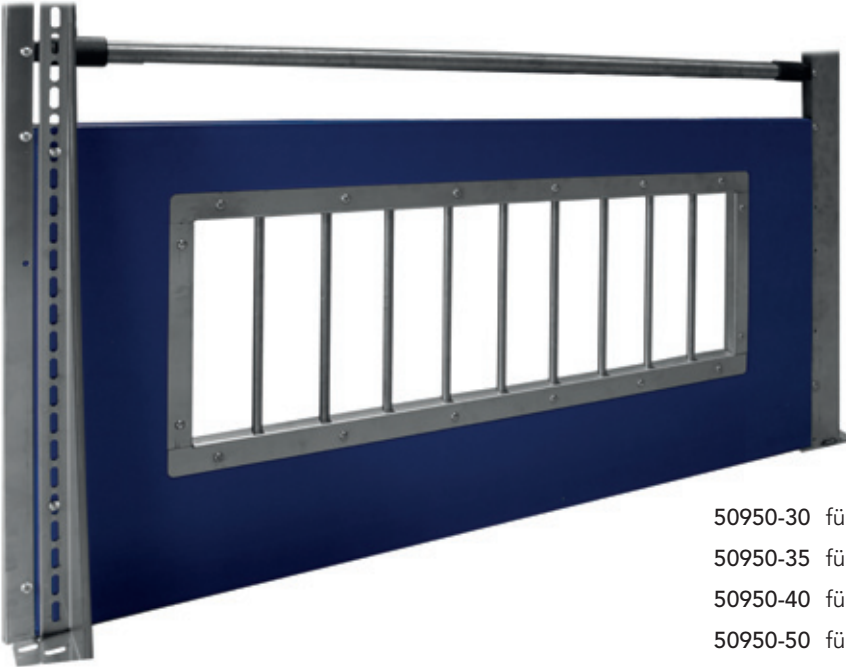

50950-30 für Trennwand 30 mm/ for wall 30 mm

50950-35 für Trennwand 35 mm/ for wall 35 mm

50950-40 für Trennwand 40 mm/ for wall 40 mm

50950-50 für Trennwand 50 mm/ for wall 50 mm



Kratzwinkel

Edelstahl, mit Tränenblech im Winkel 42°

Sehr robust und einfache Montage an Trennwand oder Querrohr

Sondermaße möglich ab 50 Stk.

Scratch bracket

Stainless steel, with teardrop (textured) sheet angled at 42°
Very robust and easy installation onto wall or cross pipe

Special sizes possible with 50 pcs or more

50675-330 Länge/ length 330 mm
für Aufzucht bis 40 KG
for weaners upto 40 KG

50675-490 Länge/ length 490 mm
für Mast bis 120 KG
for fatteners upto 120 KG

50953

Schweinedusche

Edelstahl, Anschluss ½", Wassermenge am Nippel einstellbar

























sehr robust und leicht an Trennwand und Querrohren zu montieren

Shower for pigs

stainless steel, connection ½", water-flow adjustable at the nipple

very robust and easy to mount on the partitions and cross pipes



 <p>10055-F*  50</p> <p>OPTIFLO-Tränke 1/2" 63 mm lang, für Ferkel bis 35 kg</p> <p>OPTIFLO-drinker 1/2" 63 mm long, for piglets up to 35 kg</p>	 <p>10055-K*  25</p> <p>OPTIFLO-Tränke 1/2" 78 mm lang, für Schweine, Sauen und Kälber</p> <p>OPTIFLO-drinker 1/2" 78 mm long, for pigs, sows and calves</p>	 <p>10055-S*  25</p> <p>OPTIFLO-Tränke 1/2"- 3/4" 105 mm lang, für Sauen und Eber</p> <p>OPTIFLO-drinker 1/2"- 3/4" 105 mm long, for sows and boars</p>
 <p>10055-B  25</p> <p>OPTIFLO-Tränke 3/4" 105 mm lang, für Bullen</p> <p>OPTIFLO-drinker 3/4" 105 mm long, for bulls</p>	<p>NEW</p>  <p>10098-3-57  50</p> <p>Beißnippel 1/2" 6-kant, für Mast, konstanter Wasserfluss bei 1 ltr. / min.</p> <p>Bite-drinker 1/2" hex, for fatteners, constant water flow 1 ltr. / min.</p>	<p>NEW</p>  <p>10098-8-56  50</p> <p>Beißnippel 3/8"-1/2" für Ferkel und Läufer, konstanter Wasserfluss bei 0,5 ltr. / min.</p> <p>Bite-drinker 3/8"-1/2" for piglets and weaners, constant water flow 0,5 ltr. / min.</p>
 <p>10098-4*  25</p> <p>Beißnippel 3/4" für Sauen und Mast</p> <p>Bite-drinker 3/4" for sows and fatteners</p>	 <p>10098-6*  25</p> <p>Beißnippel 3/4"-1/2" für Sauen und Mast</p> <p>Bite-drinker 3/4"-1/2" for sows and fatteners</p>	 <p>10094-3*  50</p> <p>Beißnippel 1/2" rund, für Sauen, Mast und Läufer</p> <p>Bite-drinker 1/2" round, for sows, fatteners and weaners</p>
 <p>10098-3*  50</p> <p>Beißnippel 1/2" 6-kant, für Sauen, Mast und Läufer</p> <p>Bite-drinker 1/2" hex, for sows, fatteners and weaners</p>	 <p>10098-8*  50</p> <p>Beißnippel 3/8"-1/2" für Ferkel und Läufer</p> <p>Bite-drinker 3/8"-1/2" for piglets and weaners</p>	 <p>10095  50</p> <p>Beißnippel 3/8" für Ferkel und Läufer</p> <p>Bite-drinker 3/8" for piglets and weaners</p>

* Tränke hat eine einstellbare Düse von 0,8–1–2 mm, für Hoch- oder Niederdruck

* Drinker features an adjustable orifice of 0,8–1–2 mm, for high- or low pressure.

Trogprüher aus Edelstahl | Trough-sprayers in stainless steel | Nippeltränken aus Edelstahl | Nippledrinkers in stainless steel



10097-2 50

Trogprüher 1/2"

für Sauen mit Schlitz, Wasserdurchfluss bis zu 8 ltr./min.

Sprayer 1/2"

for sows with slit, water flow up to 8 ltr./min.



10097-3 50

Trogprüher 1/2"

für Sauen mit 3 Löchern, Wasserdurchfluss bis zu 8 ltr./min.

Sprayer 1/2"

for sows with 3 holes, water flow up to 8 ltr./min.



10092-8* 50

Trogprüher 1/2"

für Mast und Läufer, mit 1/2" Innengewinde

Sprayer 1/2"

for fatteners and weaners, with 1/2" female thread



10097-5* 50

Trogprüher 1/2"

für Mast und Läufer

Sprayer 1/2"

for fatteners und weaners



10097-7 50

Trogprüher 3/8"

für Mast und Läufer, mit 3/8" Innengewinde

Sprayer 3/8"

for fatteners and weaners, with 3/8" female thread



10092-15 100

Trognippel 1/4"

für Ferkel bis Mast

Trough-nipple 1/4"

for piglets up to fatteners



10090 50

Nippeltränke 1/2"

Niederdruck

Nippledrinker 1/2"

low-pressure



10091 50

Nippeltränke 1/4"

Niederdruck

Nippledrinker 1/4"

low-pressure

NEW



10098-41 50

Beißnippel 1/2"

kurze Ausführung, 28 mm, Düse 2 mm für Niederdruck 0,2 bar

Bite-drinker 1/2"

short version, 28 mm, orifice 2 mm for low-pressure 0,2 bar

Monoflo has pig ideas.



Rohrgewinde Dichtmittel

30094-01 50ml
ca. 80 Eindichtungen
30094-02 250ml
ca. 400 Eindichtungen

Thread sealent

30094-01 50ml
approx. 80 sealings
30094-02 250ml
approx. 400 sealings



10099-1 10 | 10099-2 10

3/4" Durchbohrtrogsprüher 1"
Messing, für Sauen

3/4" Pipe-mounted sprayer 1"
brass, for sows



10092-2*  50
Trognippel 1/2"
 für Sauen und Mast
Trough-nipple 1/2"
 for sows and fatteners



10092-3*  50
Trognippel 1/2"
 für Mast und Läufer, 90 mm lang
Trough-nipple 1/2"
 for piglets up to fatteners, 90 mm long



10092-12*  50
Trognippel 1/2"
 für Läufer und Ferkel, sehr leichtgängig
 mit dünnem Stift
Trough-nipple 1/2"
 for weaners and piglets, with thin pin,
 easy to use



10092-26*  50
Trognippel 1/2"
 für Läufer und Mast
Trough-nipple 1/2"
 for weaners and fatteners



10092-10*  50
Trognippel 1/2" für Ferkel bis Mast,
 mit zusätzlicher 4 mm Düse
Trough-nipple 1/2" for piglets up to
 fatteners, with additional 4 mm orifice



10092-11*  50
Trognippel 1/2" für Ferkel bis Mast,
 mit zusätzlicher 4 mm Düse
Trough-nipple 1/2" for piglets up to
 fatteners, with additional 4 mm orifice



10092-5  50
Trognippel 1/2"
 für Ferkel bis Mast, mit 1/2" Innen-
 gewinde
Trough-nipple 1/2"
 for piglets up to fatteners, with 1/2"
 female thread



10092-38  25
Trognippel 3/8"
 für Ferkel bis Mast, mit 3/8" Innen-
 gewinde
Trough-nipple 3/8"
 or piglets up to fatteners, with 3/8"
 female thread



10092-13  25
Trognippel 1/2"
 für Sauen, Wasserfluss bis zu 12 ltr./min.,
 mit 1/2" Innengewinde
Trough-nipple 1/2"
 for sows, water flow up to 12 ltr./min.,
 with 1/2" female thread



Einstellbare Düse/
 Adjustable orifice
 0,8-1-2 mm



2 mm



3 mm



4 mm

Tränken mit * haben eine einstellbare Düse von 0,8 - 1 - 2 mm.
 Auch lieferbar: 2 - 3 - 4 mm, nicht einstellbar
 Drinkers with * have an adjustable orifice of 0,8 - 1 - 2 mm.
 Also available in : 2 - 3 - 4 mm, non adjustable.



10092-14  200
Trognippel 1/2"
 Für Sauen, Wasserfluss bis zu 12 ltr./
 min, mit 1/2" Außengewinde
Trough-Nipple 1/2"
 For sows, water flow up to 12 ltr./min.,
 with 1/2" male thread

* Tränke hat eine einstellbare Düse von 0,8–1–2 mm, für Hoch- oder Niederdruck
 * Drinker features an adjustable orifice of 0,8–1–2 mm, for high- or low pressure.



1196-1 100
Wandhalter 1/2"-1/2"
 Winkel 15°
Wall bracket 1/2"-1/2"
 angle 15°



1196-2 100
Wandhalter 1/2"-1/2"
 Winkel 45°
Wall bracket 1/2"-1/2"
 angle 45°



1196-3-1 100
Wandhalter 1/2"-3/4"
 Winkel 30°
Wall bracket 1/2"-3/4"
 angle 30°



1196-3-2 100
Wandhalter 3/4"-3/4"
 Winkel 30°
Wall bracket 3/4"-3/4"
 angle 30°



1196-62 50 | 1196-67 50
 3/4" - 3/4" | 1/2" - 1/2"
Wandhalter
 Winkel 90°, für Wasserhahn
Wall bracket
 angle 90°, for faucets



80000-Y 50
Adapter 1/2"
 für zwei Beißnippel, Abstand 100 mm,
 oben AG
Adaptor 1/2"
 for two bite-drinkers, spacing 100 mm,
 top male



1196-30 50
Rohr 1/2"
 AG/IG, zur Montage von Ventilen in
 Beckentränken
Pipe 1/2"
 male/female, for installation of valve
 into bowl-drinker



1196-6 50
Muffe 1/2"-1/2"
 Länge 35 mm
Connector 1/2"-1/2",
 length 35 mm



1196-13
Verschraubung 1/2" - 1/2", IG/AG
 mit Überwurfmutter für einfachere
 Montage, selbstdichtend
**Screw connector 1/2" - 1/2", female/
 male** with turning nut for easier instal-
 lation, self sealing



1196-7
L-Stück 1/2"-1/2" 90°
L-piece 1/2"-1/2" 90°



1196-65
L-Stück 1/2"-1/2" 135°
L-piece 1/2"-1/2" 135°



1196-10
L-Stück 1/2"-1/2" 90°
L-piece 1/2"-1/2" 90°



1196-8
T-Stück 1/2"-1/2"-1/2"
T-piece 1/2"-1/2"-1/2"

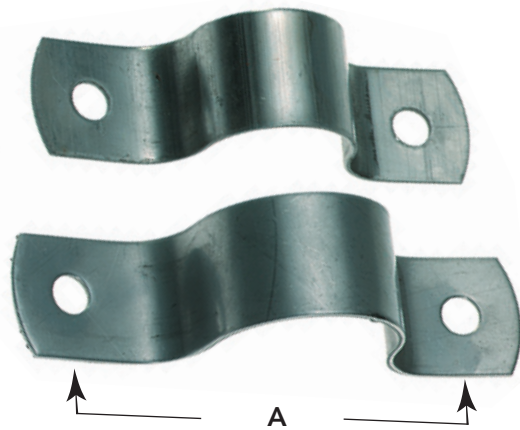

Rohrschelle
Pipe clamps

	Artikel-Nr. Article-No.	Ø Rohr Ø Pipe	A	d t	Ø Loch Ø hole
☒ 100	70020-17	3/8"	44 mm	1,2 mm	6
☒ 100	70020	1/2"	55 mm	1,5 mm	8,5
☒ 100	70021	3/4"	70 mm	1,5 mm	8,5
☒ 100	70022	1"	80 mm	1,5 mm	8,5
☒ 100	70028-2	40 mm	75 mm	2 mm	9x13
☒ 100	70025-50	50 mm	80 mm	2 mm	11
☒ 150	70025-61	60 mm	101 mm	2 mm	9
☒ 100	70025	63 mm	93 mm	2 mm	11
☒ 50	70028-1	70 mm	105 mm	2 mm	9x13
☒ 100	70026	75 mm	107 mm	2 mm	11
☒ 200	70026-81	80 mm	136 mm	1,5 mm	11
☒ 25	70028-90	90 mm	122 mm	2 mm	11
☒ 100	70028-125	128 mm	161 mm	2 mm	11
☒ 50	70027	160 mm	211 mm	3 mm	12
☒ 20	70025-100	200 mm	250 mm	3 mm	12



70023 ☒ 50
Rohrschelle
mit 20 mm Wandabstand für 1/2" Rohre
Pipe clamps
with 20 mm wall spacing for pipe 1/2"



70024 ☒ 50
Rohrführung
mit 10 mm Wandabstand für 1/2" Rohre
Pipe support
with 10 mm wall spacing for pipe 1/2"



70024-C ☒ 50
Rohrführung
Lochabstand 40 mm und 10 mm Wandabstand für 1/2" Rohre
Pipe support
holes spaced at 40 mm and 10 mm wall spacing for pipe 1/2"



70019 ☒ 100
Rohrhalter
verbindet 1/2" Wasserrohr mit 3/4" bis 1" Stahlrohr, inkl. Schraube M8 x 25 mm
Pipe holder
connects 1/2" water pipe with 3/4" to 1" metal pipe, incl. screw M8 x 25 mm



70019-2 ☒ 50
Rohrhalter
verbindet 1/2" Wasserrohr mit 3/4" bis 1" Stahlrohr, inkl. Schraube M8 x 25 mm
Pipe holder
connects 1/2" water pipe with 3/4" to 1" metal pipe, incl. screw M8 x 25 mm



70019-3 ☒ 50
Rohrhalter
verbindet 3/4" Wasserrohr mit 3/4" bis 1" Stahlrohr, inkl. Schraube M8 x 25 mm
Pipe holder
connects 3/4" water pipe with 3/4" to 1" metal pipe, incl. screw M8 x 25 mm



10096-6 ☐ 100

Schlauchtülle 1/2"
mit 1/2" AG

Hose barb 1/2"
with 1/2" male



10096-9 ☐ 100

Schlauchtülle 1/2"
mit 1/2" IG

Hose barb 1/2",
with 1/2" female



10096-10 ☐ 100

Schlauchtülle 1/2"
mit 1/2" IG, dreiteilig mit Dichtung für
schnellere Montage

Hose barb 1/2"
with 1/2" female, in 3 parts and washer
for faster assembly



10096-6-P ☐ 100

Schlauchtülle 1/2"
mit 1/2" AG, in PA66

Hose barb 1/2"
with 1/2" male, in PA66



10096-9-P ☐ 50

Schlauchtülle 1/2"
mit 1/2" IG, in PA66

Hose barb 1/2"
with 1/2" female, in PA66



10096-12 ☐ 50

Schlauchtülle 1/4"
mit 1/2" IG

Hose barb 1/4"
with 1/2" female



10096-5-7 ☐ 100

Anbauschelle 3/4"-1"
Abgang 1/2" IG, schwere Ausführung

Pipe clamp 3/4"-1"
outlet 1/2" female, heavy duty version



10096-5-7-K1

Anbauschelle 3/4"-1",
mit angeschweißter Schlauchtülle 1/2"

Pipe clamp 3/4"-1"
with welded hose barb 1/2"



10096-KIT-DK

Wasseranschluss Kit 3/4" - 1"
mit HD-Schlauch und Tülle 1/2" IG,
Länge 100cm, doppelter Abgang,
Sonderlänge ab 50 St.

Water connection kit 3/4"- 1"
with HP-hose and barb 1/2" female,
length 100 cm, two outlets, special
length from 50 pcs.



10096-KIT-Y ☐ 50

Wasseranschluss Kit 3/4"-1"
mit HD-Schlauch und Tülle 1/2" IG,
Länge 100 cm, Sonderlänge ab 50 St.

Water connection kit 3/4"-1"
with HP-hose and barb 1/2" female, length
100 cm, special length from 50 pcs.

10096-100

Schlauch 1/2", 50 m
mit Gewebe, für Hochdruck geeignet

Hose 1/2", 50 m
with webbing, suitable for high-pressure

10096-101 ☐ 1000

Schlauchschelle 1/2"
für ø 12-20 mm, 9 mm breit

Hose clamp 1/2"
for ø 12-20 mm, width 9 mm

10096-102 ☐ 250

T-Stück 1/2" T-piece 1/2"
für HD-Schlauch for HP-hose



10096-8-VE  6

Höhenversteller 1/2"

komplett Edelstahl, Rohr 650 mm, 30° gebogen

Height adjuster 1/2"

complete in stainless steel, pipe in 650 mm, bent 30°



10096-8-E  6

Höhenversteller 1/2"

Platte verzinkt, Rohr und Feder in Edelstahl, 650 mm, 30° gebogen

Height adjuster 1/2" plate galvanized,

pipe and spring in stainless steel, pipe in 650 mm, bent 30°



10096-8-S

Schwenkhalter

Edelstahl, 1/2" Rohr 620 mm, doppelter Abgang 30° gebogen mit Spielschutz

Swing bracket

stainless steel, 1/2" pipe in 620 mm, double outlet bent 30° with play guard

10096-8-K  25

Kette verzinkt in 4 mm, 250 cm lang

Chain galvanized in 4 mm, 250 cm long



10096-8-VD

Höhenversteller 1/2"

komplett Edelstahl, Rohr 620 mm, doppelter Abgang 30° gebogen

Height adjuster 1/2"

stainless steel, pipe in 620 mm, double outlet bent 30°



10096-8-DE

Höhenversteller 1/2" Platte verzinkt,

Rohr und Feder in Edelstahl, 620 mm, doppelter Abgang 30° gebogen

Height adjuster 1/2" plate galvanized,

pipe and spring in stainless steel, pipe in 620 mm, double outlet bent 30°



10096-8-S-01

Schwenkhalter

Edelstahl, 1/2" Rohr 620 mm, 4-fach Abgang 30° gebogen mit Spielschutz

Swing bracket

stainless steel, 1/2" pipe in 620 mm, quad outlet bent 30° with play guard

 <p>80380 - 380 mm 80500 - 500 mm 80760 - 760 mm 80110 - 1.000 mm </p> <p>Rohre 1/2" oben AG, unten IG, 30° gebogen</p> <p>Pipes 1/2" top male, bottom female, bent 30°</p>	 <p>80025-1 - 250 mm 80050-1 - 500 mm 80075-1 - 750 mm 80100-1 - 1.000 mm 80120-1 - 1.200 mm </p> <p>Rohre 1/2" AG/IG</p> <p>Pipes 1/2" male/female</p>	 <p>80025-2 - 250 mm 80050-2 - 500 mm 80075-2 - 750 mm 80100-2 - 1.000 mm 80120-2 - 1.200 mm </p> <p>Rohre 1/2" AG/AG</p> <p>Pipes 1/2" male/male</p>
 <p>80138 - 380 mm 80150-16 - 500 mm 80175-8 - 750 mm 80111-26 - 1.000 mm </p> <p>Rohre 1/2" oben AG, unten IG, 30° gebogen, ein Halter</p> <p>Pipes 1/2" top male, bottom female, bent 30°, one bracket</p>	 <p>80150 - 500 mm 80175 - 750 mm 80111 - 1.000 mm </p> <p>Rohre 1/2" oben AG, unten IG, 30° gebogen, zwei Halter</p> <p>Pipes 1/2" top male, bottom female, bent 30°, two brackets</p>	 <p>80260 - 600 mm 80270 - 700 mm 80200 - 1.000 mm </p> <p>Rohre 1/2" oben AG, unten IG 30° gebogen, 2. Abgang rechts, 150 mm Abstand</p> <p>Pipes 1/2" top male, bottom female bent 30°, 2. outlet right, 150 mm spacing</p> <p>Auch lieferbar 2. Abgang nach links - also available 2. outlet to the left</p>
 <p>70060-7</p> <p>Rohrhalter höhenverstellbar, passend für alle Rohre 1/2", Wandabstand 20 mm</p> <p>Pipe bracket adjustable, fits onto all pipes 1/2", wall spacing 20 mm</p>	 <p>70060-6</p> <p>Rohrhalter höhenverstellbar, passend für alle Rohre 1/2", Wandabstand 10 mm</p> <p>Pipe bracket adjustable, fits onto all pipes 1/2", wall spacing 10 mm</p>	 <p>70060</p> <p>Rohrhalter höhenverstellbar, passend für alle Rohre 1/2", Wandabstand 20 mm</p> <p>Pipe bracket adjustable, fits onto all pipes 1/2", wall spacing 20 mm</p>

80706-1



Rohr 1/2"

oben IG, unten IG, 2 Abgänge 30° gebogen, innen 350 mm, passt über PVC Panele von 35-40 mm und 500 mm hoch

Pipe 1/2"

top female, bottom female, 2 outlets bent 30°, inside 350 mm, fits over PVC panels 35-40 mm and 500 mm high

80441-2  20



Rohr 1/2"

1.000 mm, oben AG, unten IG, 2 Abgänge 30° gebogen und versetzt, passt durch Panele von 35-50 mm

Pipe 1/2"

1.000 mm, top male, bottom female, 2 outlets bent 30° and turned, fits through panels 35-50 mm



80266

Rohr 1/2" 660 mm, oben AG, unten IG, 2 Abgänge 30° gebogen, Abstand 200 mm

Pipe 1/2" 660 mm, top male, bottom female, 2 outlets bent 30°, spacing 200 mm



80706-182

Rohr 1/2"

1.000 mm, oben AG, unten IG, 2x2 Abgänge 30° gebogen und Abstand 150 mm, innen 680 mm, passt über Panele von 35-50 mm. Optional mit verstellbarem Halter Nr. 80706-183-K

Pipe 1/2"

top male, bottom female, 2x2 outlets bent 30° and spacing 150 mm, inside 680 mm, fits over PVC panels 35-50 mm. Optional with adjustable bracket no. 80706-183-K



80706-183

Rohr 1/2"

1.000 mm, oben AG, unten IG, 2 Abgänge 30° gebogen, innen 680 mm, passt über Panele von 35-50 mm. Optional mit verstellbarem Halter Nr. 80706-183-K

Pipe 1/2"

top male, bottom female, 2 outlets bent 30°, inside 680 mm, fits over PVC panels 35-50 mm. Optional with adjustable bracket no. 80706-183-K



80706-183-K  10

Rohrhalter

verstellbar, mit Platte und U-Bügel, passt zu Rohr 3/4" bis 1" und Panele 35 mm

Pipe bracket

adjustable, with plate and U-bolt, fits on pipe 3/4" to 1" and panels of 35 mm



70019  100

Rohrhalter

verbindet 1/2" oder 3/4" Wasserrohr mit 3/4" bis 1" Stahlrohr, inkl. Schraube M8 x 25mm

Pipe support

connects 1/2" or 3/4" water pipe with 3/4" to 1" metal pipe, incl. screw M8 x 25mm

DE-GM 202012004756.6



80111-53  15

Rohr 1/2"

1.000 mm, oben AG, unten IG, 2 Abgänge 30° gebogen mit Abstand 150 mm

Pipe 1/2"

1.000 mm, top male, bottom female, 2 outlets bent 30° with spacing 150 mm

80111-531

Rohr 1/2" nur unterer Abgang 1/2"

Pipe 1/2" only lower outlet 1/2"



80266-4-B

Rohr 1/2"

1.000 mm, oben AG, unten IG, 2 Abgänge 30° gebogen mit Abstand 225 mm, ohne Zirkulation

Pipe 1/2"

1.000 mm, top male, bottom female, 2 outlets bent 30° with spacing 225 mm, without circulation



80111-87-B

Rohr 1/2"

1.000 mm, oben AG, unten IG, 2 Abgänge 30° gebogen mit Abstand 150 mm, ohne Zirkulation

Pipe 1/2"

1.000 mm, top male, bottom female, 2 outlets bent 30° with spacing 150 mm, without circulation



80706-35-B  8

Rohr 1/2" 1.000 mm, innen 600 mm, oben AG, unten IG, 2 x 2 Abgänge 30° gebogen, Abstand 150 mm, passt über Panele von 35-50 mm, optional mit verstellbarem Halter Nr. 80706-183-K

Pipe 1/2" 1.000 mm, inside 600 mm, top male, bottom female, 2 x 2 outlets bent 30°, spacing 150 mm, fits over panels 35-50 mm, optional with adjustable bracket no. 80706-183-K



80706-318-B

Rohr 1/2" 1.200 mm, innen 800 mm, oben AG, unten IG, 2 x 2 Abgänge 30° gebogen, Abstand 150 mm, passt über Panele von 35-50 mm, optional mit verstellbarem Halter Nr. 80706-183-K

Pipe 1/2" 1.200 mm, inside 800 mm, top male, bottom female, 2 x 2 outlets bent 30°, spacing 150 mm, fits over panels 35-50 mm, optional with adjustable bracket no. 80706-183-K



80000-RB-01  25

Schutzbügel

Edelstahl, zum Nachrüsten über Rohre

Protector

stainless steel, can be fitted over existing pipes



80706-183-K  10

Rohrhalter

verstellbar, mit Platte und U-Bügel, passt zu Rohr 3/4" bis 1" und Panele 35 mm

Pipe bracket

adjustable, with plate and U-bolt, fits on pipe 3/4" to 1" and panels of 35 mm



80791-50-30

Rohr 1/2"

550/750 mm hoch, 600 mm breit, drei 1/2" Abgänge 25° gebogen, Abstand 200 mm, mit Schutzbügel für Ferkel bis 35 KG

Pipe 1/2"

550/750 mm high, 600 mm wide, three outlets 1/2" bent 25°, spacing 200 mm, with protector for piglets up to 35 KG



80791-81-B

Rohr 1/2"

700/1.000 mm hoch, 800 mm breit, drei 1/2" Abgänge 30° gebogen, Abstand 350 mm, mit Schutzbügel für Mastschweine

Pipe 1/2"

700/1.000 mm high, 800 mm wide, three outlets 1/2" bent 30°, spacing 350 mm, with protector for finishing pigs

NEW



80791-80

Rohr 1/2"

700 mm hoch, 850 mm breit, drei Abgänge 1/2" AG für Beckentränke, Abstand 300 mm mit zwei Halterungen

Pipe 1/2"

Height of 700 mm, width of 850 mm, three 1/2" outlets male for bowl-drinker, spacing 300 mm with two brackets



80775

Rohr 1/2"

750 mm hoch, 200 mm breit, ein 1/2" Abgang 30° gebogen

Pipe 1/2"

750 mm high, 200 mm wide, one outlet 1/2" bent 30°



80776

Rohr 1/2"

750 mm hoch, 200 mm breit, zwei 1/2" Abgänge 30° gebogen, Abstand 150 mm

Pipe 1/2"

750 mm high, 200 mm wide, two outlets 1/2" bent 30°, spacing 150 mm



80785

Rohr 1/2" 500/700 mm hoch, 450 mm breit, zwei 1/2" Abgänge 30° gebogen, Abstand 200 mm, sowie ein Abgang 1/2" AG für Montage von Tränkebecken Nr. 10058, Ferkel bis 35 KG

Pipe 1/2" 500/700 mm high, 450 mm wide, two outlets 1/2" bent 30°, spacing 200 mm, as well as outlet 1/2" male for fitting of bowl-drinker no. 10058, for piglets up to 35 KG



10053 50

Ferkelbeckenrännke

Anschluss 1/2" IG, für Ferkel bis 15 KG

Piglet bowl drinker

connection 1/2" female, for piglets up to 15 KG



10058 50

Beckenrännke

Anschluss 1/2" IG, für Ferkel bis 35 KG

Bowl drinker

connection 1/2" female, for piglets up to 35 KG



10059 20

Beckenrännke

Anschluss 1/2" IG, für Mast bis 110 KG

Bowl drinker

connection 1/2" female, for finishers up to 110 KG



80255-32

Rohr 1/2"

für Rücken an Rücken Montage von Nr. 10053, oben IG, unten 2 x AG, innen 320 mm, passend über 500 mm Trennwand von 35-40 mm

Pipe 1/2"

for back-to-back installation of no. 10053, top female, bottom 2 x male, inside 320 mm, fits over 500 mm partitions of 35-40 mm



10058-E 50

Beckenrännke

Anschluss 1/2" IG, für Ferkel bis 35 KG, oval

Bowl drinker

connection 1/2" female, for piglets up to 35 KG, oval



10059-E 25

Beckenrännke

Anschluss 1/2" IG, für Mast bis 110 KG, oval

Bowl drinker

connection 1/2" female, for finishers up to 110 KG, oval



10053-SE

Ferkeltrännke

Anschluss mit 8 mm PP Steckschlauch, kein Wasserrohr erforderlich. Empfohlener Wasserdruck 0,5 Bar

Piglet drinker

Connection with 8 mm PP click system, no water pipe needed. recommended water-pressure 0,5 bar



10059-5 25

Beckenrännke

Anschluss 1/2" IG, für Sauen in Gruppenhaltung

Bowl drinker

connection 1/2" female, for sows in groups



10059-6

Beckenrännke

Extra tief, 220 mm, für alle Sauen + Eber, Hochleistungsventil Nr. 10092-13.

Bowl drinker

Extra deep, 220 mm, for all sows + boars, with high flow valve No. 10092-13

80255-88

Rohr 1/2"

Für Rücken an Rücken Montage von Nr. 10058, unten 2 x AG, oben AG 500 mm, Höhe innen 510 mm, passend für Trennwände von 35-50 mm

Pipe 1/2"

for back-to-back installation of no. 10058, bottom 2x male, top male 500 mm, height inside 510 mm, fits over panels of 35-50 mm

80255-89

Rohr 1/2"

Für Rücken an Rücken Montage von Nr. 10059, unten 2 x AG, oben AG 500 mm, Höhe innen 600 mm, passend für Trennwände von 35-50 mm

Pipe 1/2"

for back-to-back installation of no. 10059, bottom 2x male, top male 500 mm, height inside 600 mm, fits over panels of 35-50 mm



10058-100

Beckentränke höhenverstellbar
um 300 mm, 1/2" Rohr 900 mm, für Ferkel bis 35 kg, komplett aus Edelstahl

Bowl drinker height-adjustable
by 300 mm, 1/2" pipe 900 mm, for piglets up to 35 kg, complete in stainless steel

10059-100

Beckentränke höhenverstellbar
um 170 mm, 1/2" Rohr 1200 mm, für Mast bis 110 kg, komplett aus Edelstahl

Bowl drinker height-adjustable
by 170 mm, 1/2" pipe 1200 mm, for finishers up to 110 kg, complete in stainless steel



10058-U 50

Beckentränke

Anschluss 2 x 1/2" IG, für Ferkel bis 35 KG, stets frisches Wasser

Bowl drinker

connection 2 x 1/2" female, for piglets up to 35 KG, always fresh water



10059-U 25

Beckentränke

Anschluss 2 x 1/2" IG, für Mast bis 110 KG, stets frisches Wasser

Bowl drinker

connection 2 x 1/2" female, for finishers up to 110 KG, always fresh water



10059-5-U 20

Beckentränke

Anschluss 2 x 1/2" IG, für Sauen in Gruppenhaltung, stets frisches Wasser

Bowl drinker

connection 2 x 1/2" female, for sows in groups, always fresh water



10059-7 4

Beckentränke

Anschluss 1/2" IG, für Sauen / Ferkel in der Abferkelbox

Bowl drinker

connection 1/2" female, for sows / piglets in the farrowing crate



10059-8 4

Beckentränke

Anschluss 1/2" IG, für Sauen / Ferkel in der Abferkelbox, mit Montagewinkel 4 mm

Bowl drinker

connection 1/2" female, for sows / piglets in the farrowing crate, with mounting plate 4 mm



10059-6-1 6

Beckentränke

Anschluss 1/2" IG, nur die Schale, für Aqua-Level oder andere Ventile

Bowl drinker

connection 1/2" female, only the bowl, for Aqua-Level or other valves



10059-10

Tränken Set

komplett mit Aqua-Level, Rohre, Schellen und Beckentränke, Höhe 1.000 mm, für Sauen / Ferkel in der Abferkelbox

Drinker Set

complete with Aqua-Level, pipes, clamps and bowl drinker, height 1.000 mm, for sows / piglets in the farrowing crate

50700

Aqua-Level konstante Wassermenge in Beckentränke oder Trog

Aqua-Level constant water level in bowl drinker or trough

80000-1195-S

Rohr 1/2" 1.200 mm, AG / OG, beim Einsatz in einem Trog

Pipe 1/2" 1.200 mm, male / no thread, for use in a trough

50700-120

Aqua-Level als Set, bereits montiert mit Rohr 1.200 mm

Aqua-Level as a set, already fitted with pipe 1.200 mm

Unsere Kipp-Tränke aus Edelstahl mit Aqua-Level kann werkzeuglos zum Reinigen gekippt werden. Dies verbessert die Hygiene und reduziert den Arbeitsaufwand. Die optimale Lösung für das Tierwohl.

Our Tilt-drinker in stainless steel with Aqua-Level can be tilted back easily for better cleaning. This improves the hygiene while reducing the work. The ideal solution for animal welfare.



10059-25

Kipp-Tränke

komplett mit Aqua-Level, Rohre, Schellen und Beckentränke Ø 250 mm, für Mastschweine

Tilt-drinker

complete with Aqua-Level, pipes, clamps and bowl drinker Ø 250 mm, for finishing pigs

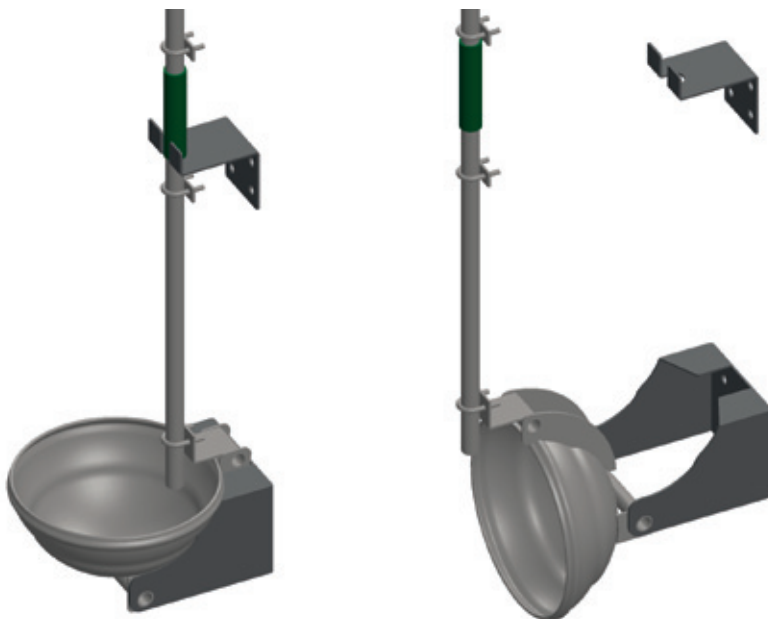



10054  6

Ferkelschale

mit Spannhaken, Ø 240 mm, Inhalt 2 ltr.

Piglet feeder

with J-hook, Ø 240 mm, capacity 2 ltr.



10056  5

Ferkelschale

mit Spannhaken, Ø 283 mm, Inhalt 3 ltr.

Piglet feeder

with J-hook, Ø 283 mm, capacity 3 ltr.



Ferkelschale

mit Spannhaken, Ø 292 mm, aber 75 mm hoch, Inhalt 4 ltr., Trennstäbe am Rand verschweißt

Piglet feeder

with J-hook, Ø 292 mm, but 75 mm high, capacity 4 ltr., dividers welded to the edge



Ferkelschale

mit Spannhaken, Ø 400 mm, Inhalt 8 ltr., für die Ferkelaufzucht

Piglet feeder

with J-hook, Ø 400 mm, capacity 8 ltr., for weaners

10057  4

für Kunststoffspalten / for plastic slats

10057-B  4

für Betonspalten / for concrete slats

10057-10  10

Trichter

aus Kunststoff für erhöhte Kapazität um 20 ltr.

Hopper

in plastic for increased capacity by 20 ltr.

10057-11  10

Verlängerung / Extension

10057-12  10

Deckel / Lid



10057-100

Ferkeltrog

100 cm, mit zwei Spannhaken und Liegesperre, 8 Futterplätze

Piglet trough

100 cm, with two snap-hooks and anti-perch bar, 8 feeding places

10057-150

Ferkeltrog

150 cm, 12 Futterplätze

Piglet trough

150 cm, 12 feeding places



NEW

Heizplatte besteht aus PVC und eine dafür speziell hergestellte Heizfolie garantiert eine gleichmäßige Wärmeverteilung. Die Breite der Heizplatten beträgt immer 500 mm und die Längen 900/1200/1500 mm. Durch die Neuauflage dieser Platten haben wir es geschafft, nicht nur die beheizte Fläche zu vergrößern, sondern auch den Stromverbrauch (Watt) signifikant zu senken. Die tatsächliche Einsparung liegt bei 30%. Das Elektrokabel ist nach wie vor mit einem flexiblen Edelstahlrohr geschützt, sodass die Tiere das Kabel nicht beschädigen können.

Heating plates consists of PVC and a heating foil particularly produced for this purpose guarantees an even heat distribution. The width of the heating plate is always 500 mm and the lengths 900/1200/1500 mm. By redesigning this new heating plate, we were not only able to increase the size of the heating area, also the power consumption is significant reduced. The saving is about 30%. The electric wire is still protected by a flexible stainless steel tube, not to be damaged by the animals.

Heizplatten | Heating plates

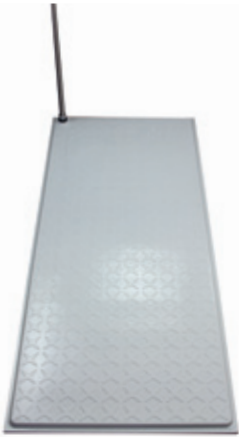

links/left

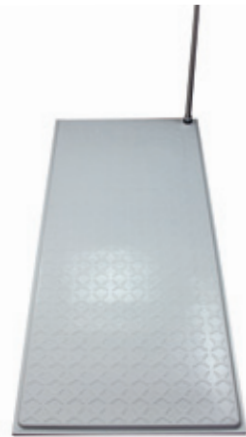

rechts/right



Mit Sensor für Anschluss an den Regler

With sensor for connection to controller

- 50873-R 900x500, 50 Watt, Kabelanschluss rechts, cable right
- 50873-L 900x500, 50 Watt, Kabelanschluss links, cable left
- 50871-R 1200x500, 70 Watt, Kabelanschluss rechts, cable right
- 50871-L 1200x500, 70 Watt, Kabelanschluss links, cable left
- 50875-R 1500x500, 90 Watt, Kabelanschluss rechts, cable right
- 50875-L 1500x500, 90 Watt, Kabelanschluss links, cable left

OHNE Sensor über Mutterplatte mit Sensor und Regler einstellbar

WITHOUT Sensor via motherplate with sensor and controller adjustable

- 50872-R 900x500, 50 Watt, Kabelanschluss rechts, cable right
- 50872-L 900x500, 50 Watt, Kabelanschluss links, cable left
- 50870-R 1200x500, 70 Watt, Kabelanschluss rechts, cable right
- 50870-L 1200x500, 70 Watt, Kabelanschluss links, cable left
- 50874-R 1500x500, 90 Watt, Kabelanschluss rechts, cable right
- 50874-L 1500x500, 90 Watt, Kabelanschluss links, cable left

50804 Regler für Heizplatten mit Sensor, max. Leistung bis 2200 W für die dahinter geschalteten Heizplatten

Controller for one heating plate with sensor, max. 2200 W capacity for the subsequent heating plates

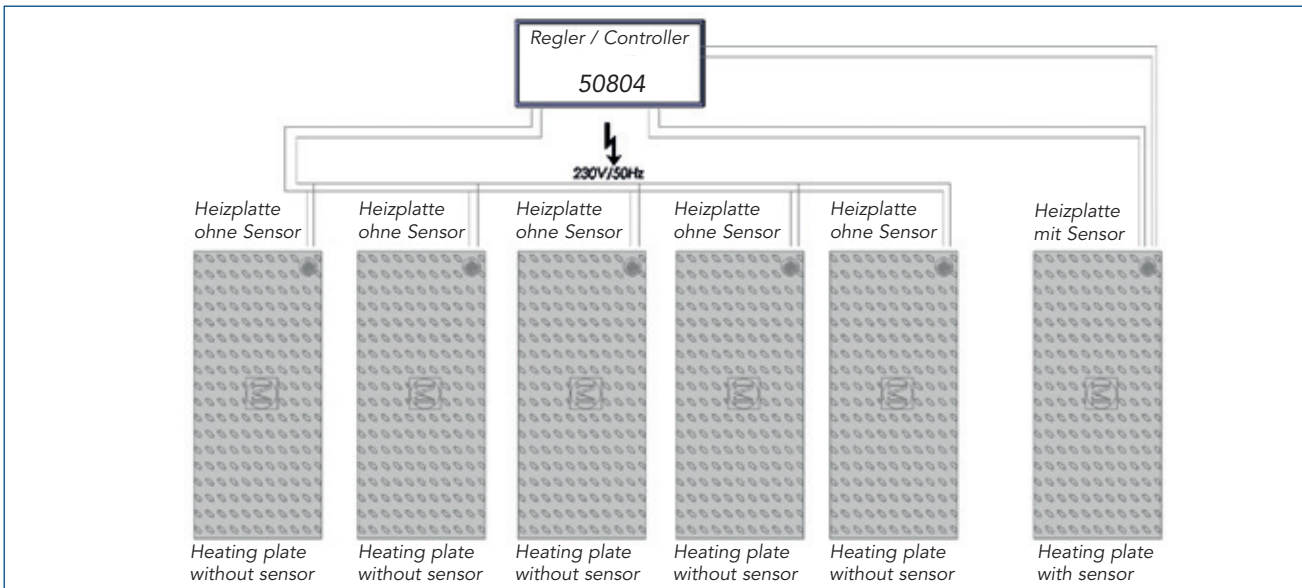

NEW



1196-15-T

Montagehilfe

für Bodenanker Nr. 1196-15

Installation tool

for floor anchors no. 1196-15



1196-15 Gewinde/Thread M10 100

Bodenanker

100 mm breit, für Betonspalten

Floor anchor

100 mm wide, for concrete slats

NEW



1196-16 Gewinde/Thread M10 100

Bodenanker

125 mm breit, für Betonspalten

Floor anchor

125 mm wide, for concrete slats

1196-23

Montagehilfe

für Bodenanker Nr. 1196-20 bis 1196-26

Installation tool

for floor anchors no. 1196-20 to 1196-26

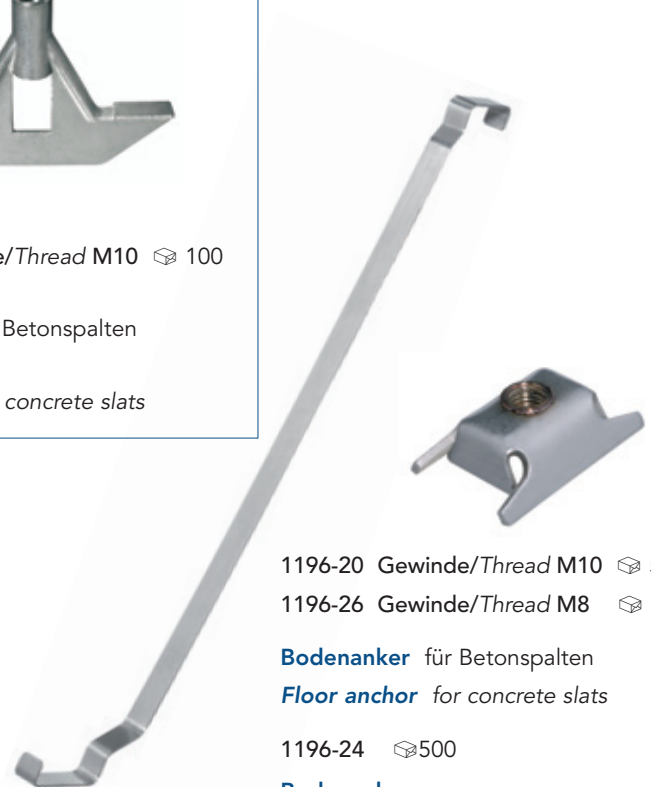

1196-20 Gewinde/Thread M10 500

1196-26 Gewinde/Thread M8 500

Bodenanker für Betonspalten

Floor anchor for concrete slats

1196-24 500

Bodenanker

für Betonspalten, nur 13 mm hoch, M10

Floor anchor

for concrete slats, only 13 mm high, M10



1196-15-1090-0 100

Schraube in Edelstahl,

Innensechskant M10 x 90 mm

Screw in stainless steel,

internal hex M10 x 90 mm



1196-21 500

Bodenanker

für Kunststoffspalten, M8

Floor anchor

for plastic slats, M8



T-Bodenanker M10

für Betonspalten

T-Floor anchor M10

for concrete slats

1196-5-50 100

M10 x 50 mm

1196-5-115 50

M10 x 115 mm

1196-5-160 50

M10 x 160 mm

Torx Schraube und Hülse - Torx screw and sleeve



1196-3-35 500

Hülse

M6 x 35 mm, Edelstahl, passend zu allen Schrauben

Sleeve

M6 x 35 mm, stainless steel, works with all screws



1196-4-20 20 mm 400

1196-4-30 30 mm 300

1196-4-40 40 mm 200

Schraube M6

Screw M6



	horizontal / horizontal	vertikal / vertical
📦 10	70079-100 = 100 / 3	70082-100 = 100 / 3
📦 10	70079-150 = 150 / 3	70082-150 = 150 / 3
📦 10	70079-200 = 200 / 3	70082-250 = 250 / 3
📦 10	70079-250 = 250 / 3	70082-300 = 300 / 3
📦 10	70079-300 = 300 / 3	70082-400 = 400 / 4
📦 10	70079-400 = 400 / 4	70082-500 = 500 / 4
📦 10	70079-500 = 500 / 4	70082-600 = 600 / 4
📦 10	70079-600 = 600 / 4	



70067-30 📦 1000

Förderrohrabstützung, Edelstahl zur Befestigung von Rohren und Kanälen aus PVC oder PE, (Länge in mm / Stärke in mm)

Wall support, stainless steel for the installation of pipes and channels in PVC or PE, (Length in mm / thickness in mm)

U-Platte gegen das Ausweiten der Rohrstützen

U-plate prevents expansion of wall supports

Verzinkt / galvanized



	horizontal / horizontal
📦 10	50415 = 150/4
📦 10	50425 = 250/4
📦 10	50440 = 400/4
📦 10	50450 = 500/4
📦 10	50460 = 600/4

Förderrohrabstützung verzinkt, horizontal
zur Befestigung von Rohren und Kanälen aus PVC oder PE, in 4 mm Stärke

Wall support galvanized, horizontal
for the installation of pipes and channels in PVC or PE, in 4 mm thickness



Holzgewinde Schrauben,
120 x 7 mm, Edelstahl

Wooden thread screws,
120 x 7 mm, stainless steel

1196-4-12-1 Offenes Ende
Open loop

1196-4-12-2 Geschlossenes Ende
Closed loop



70083-250 250x350 mm

70083-350 350x450 mm

Förderrohrabstützung verzinkt, horizontal
aus 4-kant Material und mit extra Stütze

Wall support galvanized, horizontal
made in square material and with extra support

Mit Monoflo hat man alles im Griff.



U-Bügel M6 oder M8 für die Befestigung von Kunststoffrohren, verschiedene Größen vorrätig, Ihren Bedürfnissen angepasst

U-bolts M6 or M8 for fixation of plastic pipes and channels, a large range of sizes on stock to fit all your needs

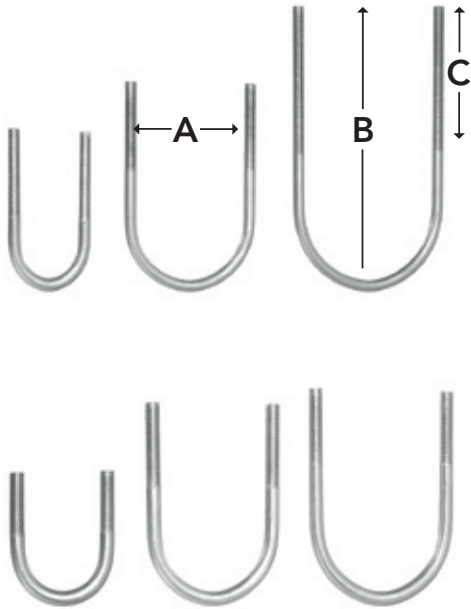

Verschiedene Größen und Modelle vorhanden, Sondergrößen ab 100 St.

Various sizes and models available, special sizes from 100 pcs.

M6	Artikel-Nr. Article-No.	A	Ø Rohr Pipe	B	C
☞ 100	70066-1	21 mm	20	60 mm	40 mm
☞ 100	70066-2	26 mm	25	65 mm	40 mm
☞ 100	70066-3	33 mm	32	70 mm	40 mm
☞ 100	70066-4	41 mm	40	80 mm	40 mm
☞ 100	70066-5	51 mm	50	90 mm	40 mm
☞ 50	70066-6	51 mm	50	132 mm	70 mm
☞ 50	70066-7	64 mm	63	100 mm	40 mm
☞ 50	70066-8	64 mm	63	129 mm	70 mm
☞ 50	70066-11	64 mm	63	165 mm	70 mm
☞ 50	70066-9	76 mm	75	115 mm	50 mm
☞ 50	70066-10	91 mm	90	140 mm	60 mm

M8	Artikel-Nr. Article-No.	A	Ø Rohr Pipe	B	C
☞ 50	70023-38	23 mm	½"	38 mm	20 mm
☞ 50	70028-47	28 mm	¾"	47 mm	30 mm
☞ 50	70035-55	35 mm	1"	55 mm	30 mm
☞ 50	70088-5	51 mm	50	90 mm	40 mm
☞ 50	70088-6	64 mm	63	100 mm	40 mm
☞ 50	70088-7	76 mm	75	115 mm	40 mm
☞ 50	70088-8	91 mm	90	120 mm	40 mm



Gegenplatte passend zu den verschiedenen U-Bügeln, hilft der Befestigung von Kunststoffrohren

Back plate for various types of U-bolts to help in fixation of plastic pipes and channels

	Artikel-Nr. Article-No.	für Ø Rohr for Ø pipe	Größe Dimension	Lochgröße size of hole
☞ 50	70067-1	20 / 25	50 x 20 x 4	7.5 x 15
☞ 50	70067-2	32 / 40	60 x 20 x 4	7.5 x 12
☞ 50	70067-3	50 / 63	88 x 20 x 4	7.5 x 15
☞ 50	70067-4	75 / 90	115 x 20 x 4	7.5 x 15
☞ 50	70067-9	33 / 50	74,5 x 20 x 4	8.5 x 20
☞ 50	70067-10	50	90 x 20 x 4	8.5 x 20
☞ 50	70067-11	63 / 75	115 x 20 x 4	8.5 x 20
☞ 50	70067-12	90	130 x 20 x 4	8.5 x 20



Kreuzbügel in M8

zur Verbindung zweier Rohre, mit Platte in 4 mm, in verschiedene Größen, Sondergrößen ab 250 St.

Cross bow clamps in M8

to connect two pipes, with plate 4 mm, in various sizes, special sizes from 250 pcs.



Artikel-Nr. Article-No.	Ø Rohr Pipe	A	Ø Rohr Pipe	B
70065-28-28	¾"	28 mm	¾"	28 mm
70065-35-35	1"	35 mm	1"	35 mm
70065-35-90	1"	35 mm	90	92 mm
70065-50-28	50 mm	52 mm	¾"	28 mm
70065-60-35	60 mm	62 mm	1"	35 mm
70065-65-28	65 mm	67 mm	¾"	28 mm
70065-90-28	90 mm	92 mm	¾"	28 mm



Wandhalter in 3 mm

mit L-Schiene 30 x 30 x 2 mm, Lochung 20 x 8.5 mm, Lochabstand Mitte-Mitte 40 mm, lieferbar in verschiedenen Längen

Wall support in 3 mm

with L-rails 30 x 30 x 2 mm, holes of 20 x 8.5 mm, hole spacing center-center 40 mm, available in various lengths

	Länge/Length
70070-120	120 mm
70070-160	160 mm
70070-200	200 mm
70070-240	240 mm
70070-280	280 mm



Winkelstangen

mit L-Schiene 30 x 30 x 2 mm, bzw. 35 x 35 x 2 mm, Lochung 20 x 8.5 mm, Lochabstand Mitte-Mitte 40 mm, lieferbar in verschiedenen Längen

Installation rails

with L-rails 30 x 30 x 2 and 35 x 35 x 2 mm, holes of 20 x 8.5 mm, hole spacing center-center 40 mm, available in various lengths

	Länge/Length	Größe/size
70069-3520	3.000 mm	35 x 35 mm
70069-3020	3.000 mm	30 x 30 mm
70069-2020	2000 mm	30 x 30 mm
70069-1280	1.280 mm	30 x 30 mm
70069-800	800 mm	30 x 30 mm
70069-640	640 mm	30 x 30 mm

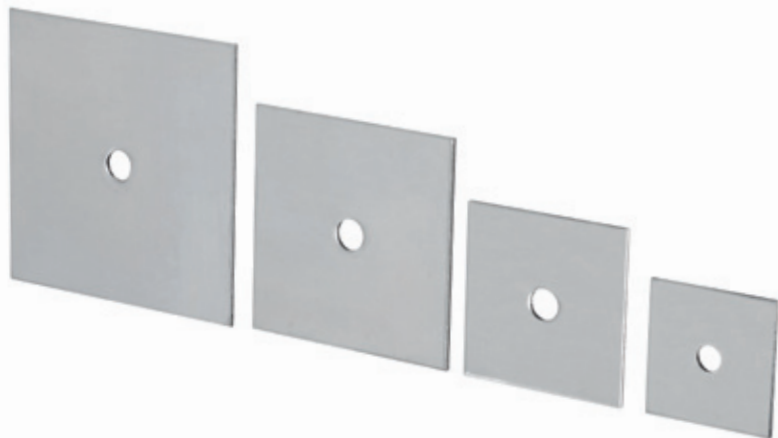

Montagescheiben in 2 mm

verschiedene Größen

Installation discs in 2 mm

various sizes

		Länge/Length	Loch/hole
📦 100	70089-100	100 x 100 mm	10.5
📦 200	70089-80	80 x 80 mm	10.5
📦 250	70089-60	60 x 60 mm	10.5
📦 500	70089-45	45 x 45 mm	8.5



70089-101 📦 50

Montageplatte M8

für Fenster, 150 x 50 x 3 mm

Mounting plate M8

for windows, 150 x 50 x 3 mm



70065-245 📦 200

Gewindestab M8 mit Öse L 245 mm

Threaded rod M8 with loop L 245 mm

70065-330 📦 100

Gewindestab M8 mit Öse L 330 mm

Threaded rod M8 with loop L 330 mm

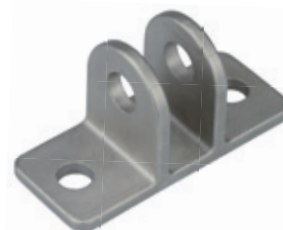

1196-63 📦 100

Scharnierhalterung aus Edelstahl

zur Wand/Türmontage

Hinge support in stainless steel

for wall/door installation



Rohrverbinder

mit NBR Gummi, luft- und wasserdichte Verbindung, lieferbar in verschiedenen Längen, Sondergrößen ab 250 St.,

Auch lieferbar ohne Gummi bei trockenen Substanzen (-NR)

Pipe connectors

with NBR Rubber, air and water tight connection, available in various lengths, special sizes from 250 pcs.,

Also available without rubber for dry substances (-NR)

Artikel-Nr. Article-No.	Ø Rohr Pipe	Länge Length	Schrauben Screws
40050-50-100	50 mm	100 mm	2
40050-50-150	50 mm	150 mm	3
40050-60-150	60 mm	150 mm	3
40050-70-150	70 mm	150 mm	3
40050-75-150	75 mm	150 mm	3
40050-60-150-NR	60 mm	150 mm	3
40050-63-150-NR	63 mm	150 mm	3
40050-102-300-NR	102 mm	300 mm	4



- 80530-120-10 - 100 mm
- 80530-120-80 - 800 mm
- 80530-120-100 - 1.000 mm
- 80530-120-120 - 1.200 mm

Fallrohr

für Flüssigfütterung, Rohr 53 x 1.5 mm passend für direkte Verbindung zu PVC Rohr 50 mm, Abgang in 120°, Sonderlängen und Größen ab 20 St.

Down pipe

for liquid feeding, pipe 53 x 1.5 mm connects directly to PVC pipe 50 mm, outlets in 120°, special lengths or sizes from 20 pcs.



Ersatzfuß aus Edelstahl

für Abferkelboxen oder Kastenstände, verschiedene Größen und Modelle vorhanden, Sondergrößen ab 50 St.

Replacement foot in stainless steel
for sow and farrowing crates, various sizes and models available, special sizes from 50 pcs.



70080-176

Platte 110 x 40 mm, Rohr 26,9 x 2 mm
Plate 110 x 40 mm, pipe 26,9 x 2 mm

70080-205

Platte 130 x 130 mm, Rohr 42,4 x 2 mm
Plate 130 x 130 mm, pipe 42,4 x 2 mm

70080-206

Platte 130 x 130 mm, Rohr 26,9 x 2 mm
Plate 130 x 130 mm, pipe 26,9 x 2 mm

70080-100

Platte 130 x 130 mm, Rohr 33,7 x 2 mm
Plate 130 x 130 mm, pipe 33,7 x 2 mm



50570-11

Kadaverwagen

Chassis VOLL Edelstahl, Luftbereifung Ø 400 mm, Winde komplett mit 5 Meter Drahtseil und Haken, Maße 175 x 49 cm

Carcass cart

chassis ALL stainless steel, air tires Ø 400 mm, winch complete with 5 meters cable and hook, size 175 x 49 cm

NEW



50570-10

Kadaverwagen

Chassis VOLL Edelstahl, wie oben aber mit Stützrädern, 3-stufig einstellbar, Maße 202 x 49 cm

Carcass cart

chassis ALL stainless steel, as above but with retractable wheels, three-stage adjustable, size 202 x 49 cm



50570-13

Kadaverwagen

Chassis VOLL Edelstahl, mit Rollen für erleichterte Bedienung, Winde mit stabilem Gurtband und Haken, mit 2 Abweiserädern, Luftbereifung (vorne: 240 x 60 mm, hinten : 260 x 85 mm), Maße 150 x 190 cm

Carcass cart

Chassis ALL stainless steel, with rolls for easier use, winch with stable webbing belt and hook, with 2 rolls, air tires (front : 240 x 60 mm, back: 260 x 85 mm) size 150 x 190 cm

Treibbretter

aus schlagfestem HDPE, mit verstärkten Ecken. Alle Größen lieferbar in 4 Farben, Kugeln im Inneren erzeugen einen Rassel-Effekt wie bei unseren Treibpaddeln

Sorting panels

Made in impact resistant HDPE, with re-enforced corners. All sizes available in 4 colours, pellets inside create a rattling-noise, just as in our sorting paddles

Groß/ Large – 120 x 74 cm ☞ 4 Stück/ 4 pcs.

- 10088-120-R rot - red
- 10088-120-S grün - green
- 10088-120-G gelb - yellow
- 10088-120-B blau - blue

Mittel/ Medium – 93 x 74 cm ☞ 5 Stück/ 5 pcs.

- 10088-93-R rot - red
- 10088-93-S grün - green
- 10088-93-G gelb - yellow
- 10088-93-B blau - blue

Klein/ Small – 45 x 74 cm ☞ 5 Stück/ 5 pcs.

- 10088-45-R rot - red
- 10088-45-S grün - green
- 10088-45-G gelb - yellow
- 10088-45-B blau - blue

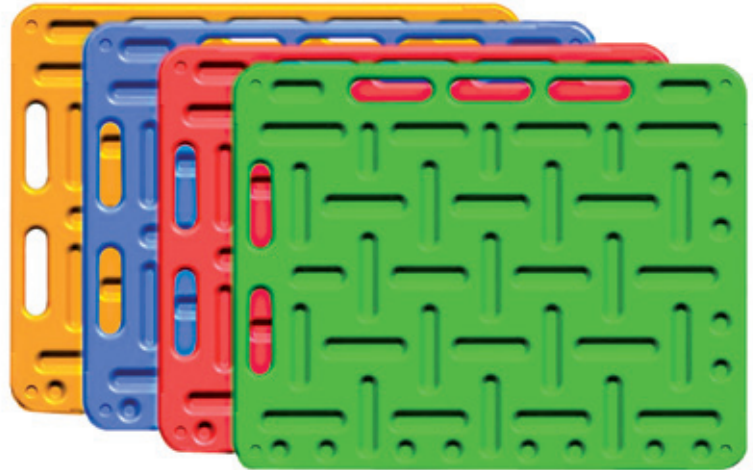

Treibpaddel

Kunststoff, Stab aus PP. Länge 103 cm, verschiedene Farben vorhanden, Sonderfarben ab 400 St.

Sorting paddle

plastic, shaft in PP. Length 103 cm, various colors available, special colors from 400 pcs.

- 10087-P rot - red ☞ 20
- 10087-S grün - green ☞ 20
- 10087-G gelb - yellow ☞ 20
- 10087-B blau - blue ☞ 20

NEW

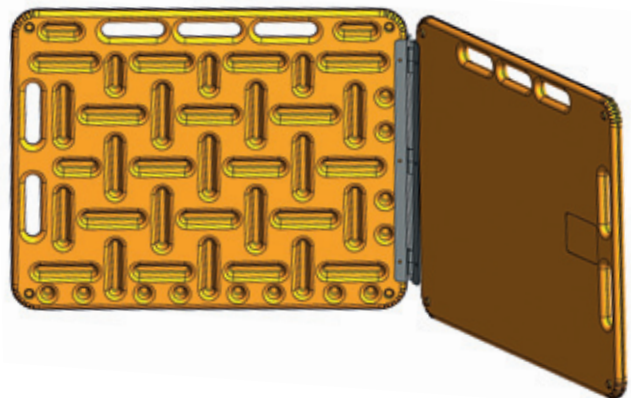

10088-600

Scharnier

Edelstahl, zur Vergrößerung der Breite, bestehend aus zwei Pfosten und einem Stab, inkl. Schrauben M6 x 40 mm

Hinge

stainless steel, increase of the width, consisting of two posts and one rod, incl. screws M6 x 40 mm



10085-27

Strohraufe

Edelstahl, Schlitz 100 x 20 mm
485 (h) x 380 (b) x 250 mm

Straw rack

stainless steel, slots 100 x 20 mm
485 (h) x 380 (w) x 250 mm



10086

Korb

Edelstahl, 370 mm oben, 130 mm
unten, Höhe 500 mm

Basket

stainless steel, 370 mm top, 130 mm
bottom, height 500 mm



50421-27

Strohwürfelhalter, verstellbar

Edelstahl, 450 x 90 mm, mit
verstellbarem Bügel von 25 – 100 mm

Strawpellet holder, adjustable

stainless steel, 450 x 90 mm, with
adjustable bracket from 25 – 100 mm



80116-5

Knabberrohr

Edelstahl, Länge 500 mm, oberer Halter
40 x 4 mm, Ø 80 mm, weitere Modelle
und Größen ab 50 St.

Nibbling pipe

stainless steel, length 500 mm, top
bracket 40 x 4 mm, bottom bracket
140 x 4 x 80 mm, Ø 80 mm, other
versions or sizes from 50 pcs.



80116-9-10

Knabberrohr

Edelstahl, Länge 380 mm, unten schräg
Halterung oben 40 x 4 mm,
Ø 80 mm, weitere Modelle und
Größen ab 50 St.

Nibbling pipe

stainless steel, length 380 mm, top
bracket 40 x 4 mm, Ø 80 mm, bottom
slanted, other versions or sizes from
50 pcs.



80116-25

Knabberrohr, verstellbar

Edelstahl, Länge 625 mm,
Rohr Ø 80 mm, verstellbar
von 30 – 70 mm, massive
Halteplatten 5 mm, weitere
Modelle und Größen ab 50 St.

Nibbling pipe, adjustable

stainless steel, length 625 mm, tube Ø
80 mm, adjustable from 30 – 70 mm,
massive wall brackets 5 mm, other ver-
sions and sizes from 50 pcs.

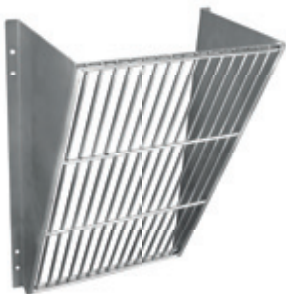

10085-1

Strohraufe

Edelstahl, zur Montage an Wände,
Maße 615 x 380 x 260 mm

Straw rack

stainless steel, for mounting to walls,
size 615 x 380 x 260 mm



10086-48-53

Strohraufe

Edelstahl, doppelte Version, 480 (h) x
530 (b) x 440 mm, für Trennwand 35-40
mm, Stababstand 20 mm

Straw rack

stainless steel, double version, 480 (h) x
530 (w) x 440 mm, for panels of 35-40
mm, wire distance 20 mm



50770

Pellet Automat, 17 Liter

Edelstahl, geeignet für alle Pellet Sorten

Pellet Dispenser, 17 litre

stainless steel, suitable for all kinds of
pellets



10086-48-53-HZ

Strohraufe

feuerverzinkt, 480 (h) x 530 (b) x 220 mm
Stababstand 20 mm, Stab Ø 8 mm

Straw rack

hot-galvanized, 480 (h) x 530 (b) x 220 mm
wire distance 20 mm, wire Ø 8 mm



10086-48-53-Z

Strohraufe

feuerverzinkt, doppelte Version, 480 (h) x 530 (b) x 440 mm, für Trennwand 35-40 mm, Stababstand 20 mm, Stab Ø 8 mm

Straw rack

hot-galvanized, double version, 480 (h) x 530 (b) x 440 mm, for panels of 35-40 mm, wire distance 20 mm, wire Ø 8 mm



Strohraufe

feuerverzinkt, doppelte Version, 480 x 500 x 620 mm, für Trennwand 35 mm

Straw rack

hot-galvanized, double version, 480 x 500 x 620 mm, for panels of 35 mm

10086-48-62-42 Stababstand 42 mm
wire distance 42 mm

10086-48-62-81 Stababstand 81 mm
wire distance 81 mm



10086-48-53-HD6

Strohraufe

feuerverzinkt, 480 (h) x 530 (b) x 220 mm
Stababstand 20 mm, Stab Ø 6 mm

Straw rack

hot-galvanized, 480 (h) x 530 (b) x 220 mm
wire distance 20 mm, wire Ø 6 mm



10086-48-53-ZD6

Strohraufe

feuerverzinkt, doppelte Version, 480 (h) x 530 (b) x 440 mm, für Trennwand 35-40 mm, Stababstand 20 mm, Stab Ø 6 mm

Straw rack

hot-galvanized, double version, 480 (h) x 530 (b) x 440 mm, for panels of 35-40 mm, wire distance 20 mm, wire Ø 6 mm



10086-50-55-Z

Strohraufe

feuerverzinkt, 500 (h) x 550 (b) x 400 mm
Stababstand 20 mm, Stab Ø 8 mm

Straw rack

hot-galvanized, 500 (h) x 550 (w) x 400 mm
wire distance 20 mm, wire Ø 8 mm



10086-Z

Korb

feuerverzinkt, Ø 370 mm oben, Ø 130 mm unten, Höhe 500 mm

Basket

hot-galvanized, Ø 370 mm top, Ø 130 mm bottom, height 500 mm



10086-Z-B

Kugel

feuerverzinkt, Ø 290 mm

Ball

hot-galvanized, Ø 290 mm

Moufflo has pig ideas.





50776

Beißrolle

Bio-Material, innen Ø 35 mm, Länge 150 mm. Das axiale Loch ermöglicht auch das Aufhängen der Beißrolle

Bite-roll

natural fiber, inside Ø 35 mm, length 150 mm. The axial hole also allows the suspension of the bite-roll



50779

Beißrolle

HDPE Kunststoff, innen Ø 35 mm, Länge 200 mm

Bite-roll

HDPE plastic, inside Ø 35 mm, length 200 mm



50778

Beißrolle

Bio-Material, innen Ø 35 mm, Länge 200 mm

Bite-roll

natural fiber, inside Ø 35 mm, length 200 mm



50788

Wandhalter für Beißrolle

Edelstahl, passend für Beißrolle Nr. 50776 mit Länge 150 mm

Wall bracket for Bite-roll

stainless steel, fits to bite-roll 50776 with length 150 mm



50771

Beißkugel

Bio-Material, Ø 75 mm

Bite-ball

natural fiber, Ø 75 mm



50772

Beißstern

Bio-Material, Ø 175 mm

Bite-ring

natural fiber, Ø 175 mm



50773

Kette

Verzinkt, Glieder 40x15x4 mm, Länge 750 mm

Zum Aufhängen der Beißrolle, -Kugel und -Stern

Chain

Galvanized, links 40x15x4 mm, length 750 mm

For suspension of bite-roll, -ball, -ring

50773-E

Kette Edelstahl

Chain stainless steel



70838

Halter für Kette

Edelstahl, inkl. M8 Mutter und Scheibe

Bracket for chain

stainless steel, incl. M8 nut and disc



70839

Doppelhalter für Kette

Edelstahl, für zwei Buchten, inkl. M8 Mutter und Scheibe

Double bracket for chain

stainless steel, for two pens, incl. M8 nut and disc

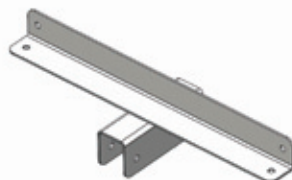

70839-35

T-Halter für Kette

Edelstahl, für Montage über 35 mm Trennwand

T-bracket for chain

In stainless steel, for assembly onto 35 mm wall

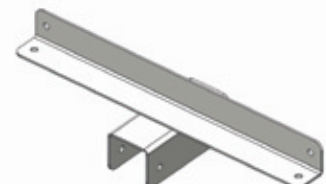

70839-50

T-Halter für Kette

Edelstahl, für Montage über 50 mm Trennwand

T-bracket for chain

In stainless steel, for assembly onto 50 mm wall

Desinfektionsmatte

aus robustem und saugfähigem Gewebematerial, für alle flüssigen Desinfektionsmittel geeignet, hilft Verschleppung von Keimen zu verhindern.

Verschiedene Größen und Farben.

Disinfection Mat

made from robust and absorbent fabric material can be used for all liquid disinfectants, helps to prevent the spread of germs.

Various sizes and colors.



Groß/Large – 90 x 60 cm

- 20073-R rot - red
- 20073-S grün - green
- 20073-G gelb - yellow
- 20073-B blau - blue

Klein/Small – 60 x 45 cm

- 20074-R rot - red
- 20074-S grün - green
- 20074-G gelb - yellow
- 20074-B blau - blue



50495-10

Wandhalter für Behälter 10 Liter

Edelstahl, 30 cm x 30 cm

Wall bracket for containers 10 litre

stainless steel, 30 cm x 30 cm



50495-20

Wandhalter für Behälter 20 Liter

Edelstahl, 38 cm x 35 cm

Wall bracket for containers 20 litre

stainless steel, 38 cm x 35 cm



50953

Schweinedusche

Edelstahl, Anschluss 1/2", Wassermenge am Nippel einstellbar

sehr robust und leicht an Trennwand und Querrohren zu montieren

Shower for pigs

stainless steel, connection 1/2", water-flow adjustable at the nipple

very robust and easy to mount on the partitions and cross pipes



10050 2

Beckenränke 1/2"

schwarz emailliert, glatte Oberfläche, mit Edelstahlzunge

Bowl drinker

black enamel, coating and stainless steel nose plate



10051 50

Auto-Tanker 1/2"

Edelstahl, für Montage an Tröge, mit Schwimmerventil bis zu 11 ltr./min.

Auto-Tanker 1/2"

stainless steel, for mounting into troughs, with float valve up to 11 ltr./min.

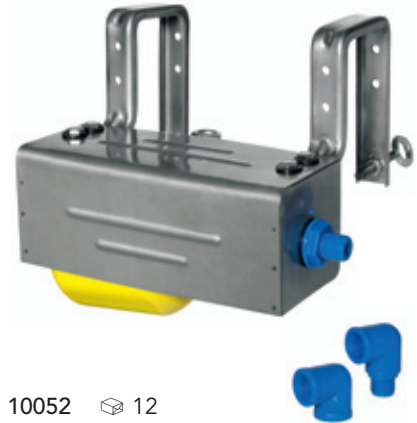

10052 12

Megaflo 1/2"

Edelstahl, für Montage an Tröge, mit Hochleistungs Schwimmerventil bis zu 28 ltr./min.

Megaflo 1/2"

stainless steel, for mounting into troughs, with high performance float valve up to 28 ltr./min.



10096-8-VD

Höhenversteller 1/2"

komplett Edelstahl, Rohr 620 mm, doppelter Abgang 30°, ideal für Kälber in Kombination mit Optiflo Nr. 10055-K

Height-adjuster 1/2"

complete in stainless steel, pipe 620 mm, double outlet 30°, for calves in combination with Optiflo no. 10055-K



80788-5-110

Rohr 3/4"

1.100 mm mit Umlauf, 2 x 2 Abgänge in 30°, Abstand 150 mm, für Bullen in Kombination mit Optiflo Nr. 10055-B

Pipe 3/4"

1.100 mm with circulation, 2 x 2 outlets in 30°, spacing 150 mm, for bulls in combination with Optiflo no. 10055-B



50093

Milchwärmer

komplett Edelstahl, von 0°C bis 40°C stufenlos einstellbar

Milk heater

all stainless steel, adjustable from 0°C up to 40°C



10055-K 25

OPTIFLO Tränke 1/2"

Edelstahl, 78 mm lang, für Kälber

OPTIFLO-drinker 1/2"

all stainless steel, 78 mm long, for calves



10055-B 25

OPTIFLO Tränke 3/4"

Edelstahl, 105 mm lang, für Bullen

OPTIFLO-drinker 3/4"

all stainless steel, 105 mm long, for bulls

Ein Glück, dass nicht alle Schweine sind.



50514  2

Stiefelreiniger

Chassis VOLL Edelstahl, Anschluss direkt an die Wasserleitung, das Vakuum saugt flüssige Reinigungsmittel an und verteilt sie über die 5 Nylon-Bürsten, Maße 90 x 26 x 55 cm

Boot cleaner

frame ALL stainless steel, connects directly to water-line, this creates a vacuum that pulls up cleaning liquid and distributes it through the 5 nylon brushes, size 90 x 26 x 55 cm



50516

Stiefelreiniger

wie Standardversion, jedoch mit Auffangwanne, das Schmutzwasser wird aufgefangen und abgeleitet, Abgang in 1½" Maße, 115 x 50 x 55 cm (H x B x T)

Boot cleaner

as the standard version, but with reservoir, the dirty water remains in the reservoir and then can be disposed, outlet 1½" size, 115 x 50 x 55 cm (H x W x D)

NEW













50517













Stiefelreiniger, Hochdruck

komplett aus Edelstahl, ½" Rohranschluss mit 3 Hochdruckdüsen, reinigt schnell und effektiv, einfache Bedienung und Montage

Boot cleaner, high pressure

all stainless steel, ½" pipe connection with 3 high pressure nozzles, fast and effective boot cleaning, easy handling and installation

<p>U-Pfosten <i>U-post</i></p>  <p>3310-050-2 500 mm</p>	<p>Schrauben mit Rundkopf siehe Katalog - Seite 19 <i>Screws with round head</i> look for catalogue page 19</p> 	<p>Wand-Pfosten <i>Wall-post</i></p>  <p>3310-050-4 500 mm</p>	
<p>Haupt-Pfosten Omega <i>Main-post Omega</i></p>  <p>3310-050-6 500 mm</p>	<p>Schrauben-Hülse siehe Katalog - Seite 19 <i>Sleeve for screws</i> look for catalogue page 19</p> 	<p>Torhaken-Pfosten <i>Door-post</i></p>  <p>3310-050-8 500 mm</p>	
<p>Bodenwinkel <i>Bottom elbow</i></p>  <p>3310-00 90/120/6 mm</p>	<p>Handgriff <i>Handle</i></p>  <p>3310-01</p>	<p>Bodenwinkel gewinkelt <i>Bottom elbow bent</i></p>  <p>3310-02</p>	
<p>Sauentröge tiefgezogen, ohne Schweißen, ohne Ecken, seitliche Löcher zur Befestigung in der Abferkelbox können nach Kundenvorgabe gestanzt werden, ab 50 St.</p> <p>50390-480 in 1.5 mm, Größe 480 x 400x 250 mm tief</p> <p>50390-520 in 1.2 mm, Größe 520 x 385 x 240 mm tief</p>			<p>Sow troughs deep drawn, no welding, no corners, holes on the sides for fixation into a farrowing crate can be punched as per your requirement, from 50 pcs.</p>  <p>50390-480 in 1.5 mm, size 480 x 400x 250 mm deep</p> <p>50390-520 in 1.2 mm, size 520 x 385 x 240 mm deep</p>

<p>U-Pfosten <i>U-post</i></p>  <p>3310-075-2 750 mm 3310-100-2 1000 mm</p>	<p>Trennwandstabilisierer <i>Stabilizer for wall</i></p>  <p>3310-075-3 780 mm 3310-100-3 1030 mm</p>	<p>Wand-Pfosten <i>Wall-post</i></p>  <p>3310-075-4 750 mm 3310-100-4 1000 mm</p>
<p>H-Pfosten <i>H-post</i></p>  <p>3310-075-5 750 mm 3310-100-5 1000 mm</p>	<p>H-Pfosten mit Platte <i>4 mm, rechts</i> <i>H-post with plate 4 mm, right</i></p>  <p>3310-075-5-PR 750 mm 3310-100-5-PR 1000 mm</p>	<p>H-Pfosten mit Platte <i>4mm, links</i> <i>H-post with plate 4mm, left</i></p>  <p>3310-075-5-PL 750 mm 3310-100-5-PL 1000 mm</p>
<p>Haupt-Pfosten Omega <i>Main-post Omega</i></p>  <p>3310-075-6 750 mm 3310-100-6 1000 mm</p>	<p>Haupt-Pfosten Omega <i>mit Platte 4mm</i> <i>Main-post Omega with plate 4mm</i></p>  <p>3310-075-6-P 750 mm 3310-100-6-P 1000 mm</p>	<p>Torhaken-Pfosten <i>Door-post</i></p>  <p>3310-075-8 750 mm</p>
<p>Torhaken-Pfosten mit Sicherung 1000 mm <i>Door-post with lock</i> 1000 mm</p>  <p>3310-100-7 (rechts / right) 3310-100-8 (links / left)</p>	<p>Stabilisierer <i>Stabilizer</i></p>  <p>3310-075-9 750 mm 3310-100-9 1030 mm</p>	

50013

Mischbehälter 60 Liter

Rührwerk und Ansaugleitung in Edelstahl, Behälter in LDPE Material, inkl. Netzteil und Zeitschaltuhr

Vorteile gegenüber des Vorgängermodells:

- Inhalt erhöht auf 60 Liter von bisher 50 Liter
- Größerer Deckel für besseren Zugang
- Innere Boden um 5° in Richtung Ansaugstab und Ablaufstopfen geneigt, Inhalt kann somit fast rückstandlos angesaugt werden – äußerer Boden ist jedoch waagrecht
- Wasserablauf erleichtert das Reinigen und Ausspülen von Behälter
- Verbesserter Fahrwagen aus Edelstahl, optional

NEW



50013

Mixing tank 60 liter

mixing unit and suction pipe in stainless steel, tank in LDPE material, incl. power supply and timer

Advantages compared to its previous model:

- Content increased to 60 ltr. from 50 ltr.
- Larger lid for better access
- Inner floor inclined by 5° towards the suction pipe and drain plug, content can thus be used up almost without residue, however the outer floor is horizontal
- Cleaning and rinsing of tank considerably easier
- Improved trolley in stainless steel, optional



50012-W-60

Fahrwagen

für Mischbehälter, komplett Edelstahl, Reifen aus Vollgummi, passende Montageplatte zum Befestigen gängiger Dosierer

Trolley

for mixing tank, all stainless steel, wheels in solid rubber, mounting plate is suited for common dosing devices



50014

Dosatron

Dosierpumpe 0.2% - 2%, Modell D25 RE2

Dosatron

doser pump 0.2% - 2%, model D25 RE2



50015

Dosatron

Dosierpumpe 1% - 5%, Modell D25 RE5

Dosatron

doser pump 1% - 5%, model D25 RE5

Mit Monoflo hat man alles im Griff.



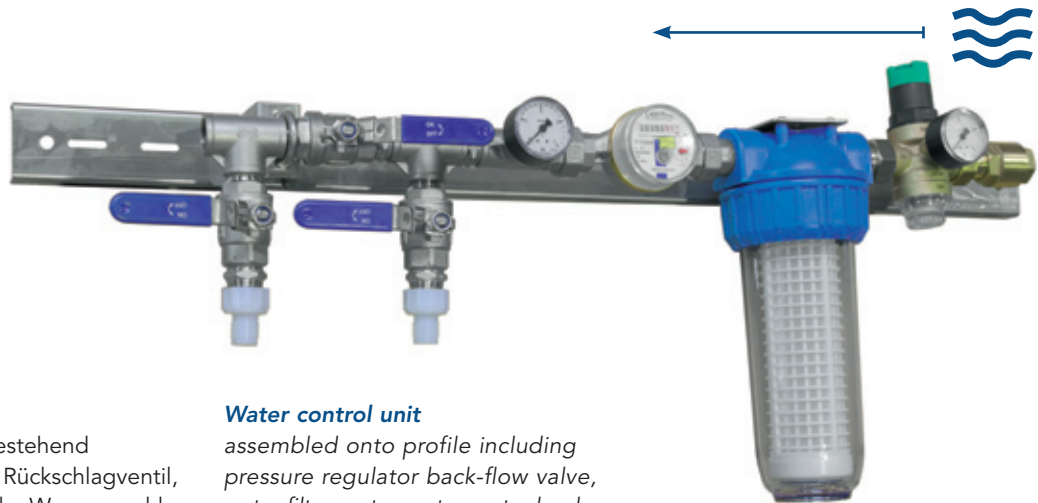

50010

Armaturen Einheit

montiert auf Profil bestehend aus Druckreduzierer, Rückschlagventil, Wasserfilter, Wasseruhr, Wasseranschluss mit By-Pass, für Medicator, alles in 3/4", Breite 800 mm

Water control unit

assembled onto profile including pressure regulator back-flow valve, water filter, water meter, water hook-up with by-pass for medicator, all in 3/4", width 800 mm



50001

Wasseruhr 3/4"

max. 10 bar, Wasserdurchfluss 3 cbm/h

Water meter 3/4"

max. 10 bar, water flow 3 cbm/h

50002

dto. in 1" - Same in 1"



50020

Wasserfilter 3/4" aus Kunststoff, mit wiederverwendbarem Filtereinsatz in 90 micron

Water filter 3/4" in plastic, with reusable filter cartridge in 90 micron

50022

Filtereinsatz zum Austausch
Cartridge for replacement



50030 - 1/2"

50031 - 3/4"

50032 - 1"

Druckreduzierer

1.5 - 4 bar einstellbar

Pressure reducer

adjustable 1.5 - 4 bar



60100

Druckregulierer 1/2"

in Delrin, Ausgang 3/4" AG, bis 0,2 bar einstellbar

Pressure regulator 1/2"

in Delrin, outlet 3/4" male, adjustable up to 0,2 bar



60300

Druckregulierer 1/2"

in Delrin, Ausgang 3/4" AG, von 0,2 - 1 bar einstellbar

Pressure regulator 1/2"

in Delrin, outlet 3/4" male, adjustable from 0,2 - 1 bar



60324

Druckregulierer 1/2"

wie 60300 von 0,2 - 1 bar, komplett mit T-Stück und Manometer

Pressure regulator 1/2"

as 60300 from 0,2 - 1 bar, complete with T-piece and gauge

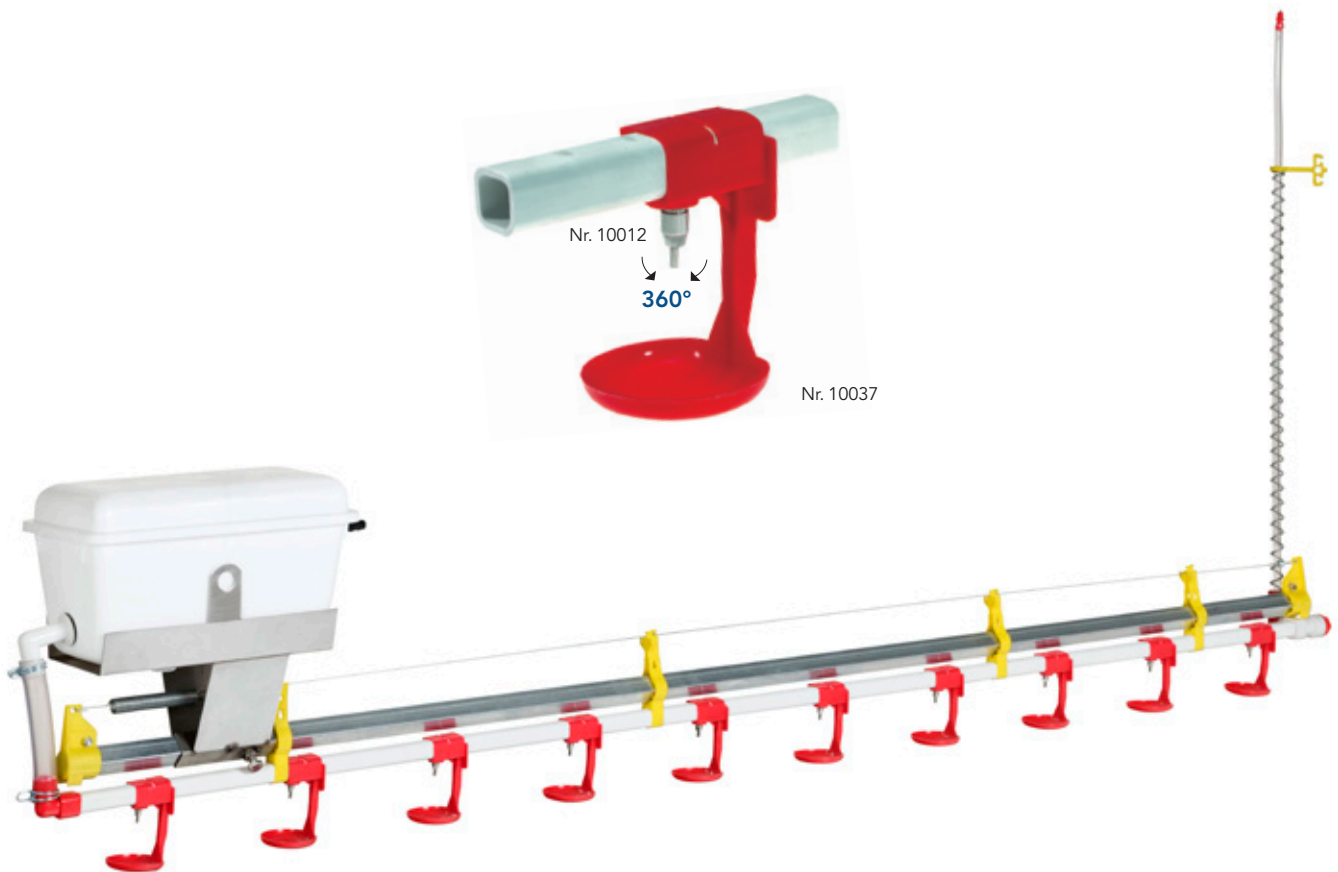

10061-200-1237

Automatische Strangtränke 2 m

Strangtränken haben sich die letzten 20 Jahre in Großanlagen sehr gut bewährt. Jetzt bieten wir diese Tränken auch als Set für den Kleintierhalter an.

Wir liefern Ihnen eine Geflügel Strangtränke 2 m lang mit 10 Nippeltränken und Schalen, komplett montiert, zum sofortigen Einsatz ab dem 3. Lebenstag.

Kaufen – Auspacken – Anschließen – Tränken

Die Strangtränke ist universell einsetzbar für:

- Broilermast bis 160 Tiere
- Elterntiere bis 50 Tiere
- Entenmast bis 60 Tiere
- Legehennen bis 60 Tiere

Die klaren Vorteile sind:

- Hygienisch
- Preiswert
- Verschleißfrei
- Bedienerfreundlich
- Optimale Vitaminübergabe

Stets frisches Wasser

10061-200-1237

Automatic drinker in 2 m

The automatic drinker lines with nipples have become the standard in large and modern poultry farms. Now we are introducing this concept also for small scale farms.

We supply you a poultry drinker in 2 m length with 10 nipples and drip-cups, completely pre-assembled and ready to use for chicks from the 3rd day.

Order – unpack – connect – start

Our drinker can be used for all birds:

- Broilers up to 160 birds
- Breeders up to 50 birds
- Layers up to 50 birds
- Ducks up to 60 birds

The clear advantages are:

- Hygienic
- Economical
- Low maintenance
- User friendly
- Easy to give additives

Always fresh water



10010 200

Nippeltränke 1/8"

Edelstahl, für Elterntiere und Legehennen

Nippeldrinker 1/8"

stainless steel, for parents and layers



10011 300

Nippeltränke 1/8"

Edelstahl, für Elterntiere und Legehennen

Nippeldrinker 1/8"

stainless steel, for parents and layers



10022 1000

Nippeltränke 1/8"

innen Edelstahl, außen Delrin, für Elterntiere und Legehennen

Nippeldrinker 1/8"

inside stainless steel, outside Delrin, for parents and layers



10012 200

Nippeltränke 1/8"

Edelstahl, sehr leichtgängig, ideal für Aufzucht, Hähnchen und Enten

Nippeldrinker 1/8"

stainless steel, very smooth pin, ideal for rearing, broilers and ducks



10012-S 200

Nippeltränke 1/8"

kurzes Modell, Oberkegel arretiert, sonst wie 10012

Nippeldrinker 1/8"

short model, top dolly locked-in, otherwise as 10012



10025 1000

Nippeltränke 1/8"

innen Edelstahl, außen Delrin, leichtgängig, ideal für Aufzucht und Hähnchen

Nippeldrinker 1/8"

inside stainless steel, outside Delrin, smooth pin, ideal for rearing and broilers

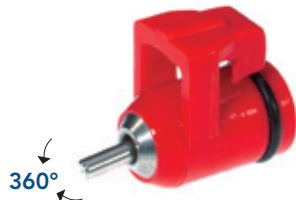

10023 500

MONODROP-Nippeltränke

dosierte Wasserabgabe, Stift sehr leichtgängig, geeignet für alle Tiere

MONODROP-Nippeldrinker

controlled water release, pin very smooth, suitable for all birds



10023-1

Sattel

zum MONODROP Nipple, für Rohr 22 x 22 mm, ohne Kleben

Saddle

to MONODROP nipple, for pipe 22 x 22 mm, no glue needed



10023-2

Sattel

zum MONODROP Nipple, für Rohr 3/4" (26.9 mm), ohne Kleben

Saddle

to MONODROP nipple, for pipe 3/4" (26.9 mm), no glue needed

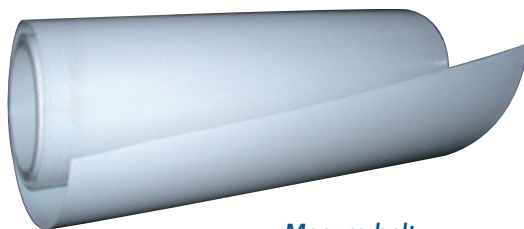

30090

Kotband

in 1 mm, hergestellt aus speziellen PP Material mit Zugfestigkeit von 300 KG/cm² und Schlagfestigkeit 75 KG/cm

Breite bis zu 1.900 mm, Länge nach Kundenwunsch

Manure belt

in 1 mm, manufactured from special PP material with tensile strength of 300 KG/cm² and impact resistance to 75 KG/cm

Width up to 1.900 mm, length as per customer requirement

Manofo - und der Tag gehört dir.





10037

Auffangschale

einarmig, für Nippelrohr 22 mm vierkant, mit Bügelverschluss leicht zu montieren, geeignet für alle Tiere

Drip-cup

single arm, for 22 mm square nipple pipe, with snap-lock for easy mounting, suited for all birds



10035

Auffangschale

einarmig, für Nippelrohr 3/4" rund, mit Bügelverschluss leicht zu montieren, geeignet für alle Tiere

Drip-cup

single arm, for 3/4" round nipple pipe, with snap-lock for easy mounting, suited for all birds



10036

Rundschalentränke

für Nippelrohr 22 mm vierkant, passt unter Nippeltränken Nr. 10010 und Nr. 10022, mit Snap-Verschluss leicht abzunehmen, geeignet für Aufzucht

Round cup-drinker

for 22 mm square nipple pipe, fits underneath nippledrinkers no. 10010 and no. 10022, with snap-lock for easy removal, suited for rearing

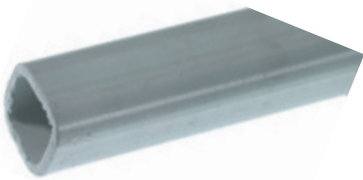

20010

Nippelrohr

22 mm vierkant in PVC, Länge nach Wunsch

Nipple pipe

22 mm square in PVC, length as per request



20016

Adapter vierkant/rund

zwischen 22 mm Vierkantrohr und 3/4" Schlauch

Adapter square/round

between 22 mm square pipe and 3/4" hose



20017

Stopfen

für 22 mm Rundrohr

Plug

for 22 mm round pipe



20015

Dehnungskupplung

für 22 mm Vierkantrohr

Expansion connector

for 22 mm square pipe



20021

Schlauchverbinder

100 mm lang, für 22 mm Vierkantrohr

Hose connector

100 mm long, for 22 mm square pipe



20015-1 für/for 20021

20015-2 für/for 20015

Klammern

verzinkt, für die Rohrverbinder

Clamps

galvanied, for the pipe connectors

30010

Tank 8 ltr.

mit Deckel (Nr. 30014) und Stopfen (Nr. 30015)

Tank 8 ltr.

with lid (30014) and plug (30015)

30011

Tank 8 ltr.

wie oben, mit einem Ausgangsloch 27 mm für den Winkel ¾" Nr. 30031

Tank 8 ltr.

as above, with one outlet hole of 27 mm for the outlet ¾" No. 30031

30012

Tank 8 ltr.

wie oben, mit zwei Ausgangslöchern 27 mm für den Winkel ¾" Nr. 30031

Tank 8 ltr.

as above, with two outlet holes of 27 mm for the outlet ¾" No. 30031

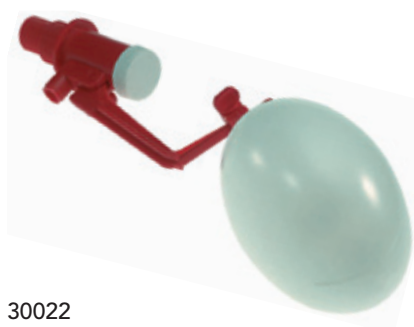

30022

Schwimmerventil

für Tank 8 ltr., Anschluss ½" AG

Float valve

for tank 8 ltr., connection ½" male



30031

Auslauf ¾"

für Tank 8 ltr., Winkel 90°

Outlet ¾"

for tank 8 ltr., angle 90°



14725

Adapter rund/vierkant

zwischen Druckregulierer (rund 26,6 mm) zu 22 mm vierkant Rohr

Adapter round/square

between pressure regulator (round 26.6 mm) and 22 mm square pipe



60500-BY

Spezialregulierer

mit Feineinstellung und hohem Wasserdurchfluss, komplett mit Sichtrohr, Befestigungsklammern, ¾" Rohranschluss und integrierter Hochdruckspülung für die Tränklinie

Pressure regulator

with fine adjustment and high water-flow, complete with sight tube, mounting bracket, connection to ¾" round pipe and integrated high-pressure flushing for drinker line



60600

Ausgleich-Spezialregulierer

mit zwei Sichtrohren für Einbau in die Mitte der Tränklinie, wenn Gefälle in der Tränklinie mehr als 40 cm ist, kein Wasseranschluss

Slope regulator

with two sight tubes for installation in middle of drinker line, when slope in the line is more than 40 cm, no water connection



60510

Wasseranschluss

zu Druckregulierer Nr. 60500, Spiralschlauch 6 mtr. lang mit Anschluss ½" zur Hauptleitung

Water connection

to pressure reducer No. 60500, spiral-hose 6 mtr. long with adapter ½" to the main water line

60511

Wasseranschluss

wie oben, aber in 9 mtr. Länge

Water connection

as above, but in 9 mtr. length

60070

Endstück für 4-kant Rohr, komplett mit Sichtrohr, Kugel und Wasserablass zum Durchspülen

Endpiece for square pipe, complete with sight tube, ball and water drain for flushing of the pipe

60071

Endstück für Rundrohr, sonst wie Nr. 60070

Endpiece for round pipe, rest as no. 60070



60072

Endstück für 4-kant Rohr, komplett mit Sichtrohr, und 2 Kugelhähnen für leichteres Durchspülen

Endpiece for square pipe, complete with sight tube, and two ball valves for easier flushing

60073

Endstück für Rundrohr, sonst wie Nr. 60072

Endpiece for round pipe, rest as no. 60072



10067

Seilrolle Ø 60 mm

Pulley Ø 60 mm

60061

Drahtseil verzinkt in 4 mm

Cable galvanized in 4 mm

60062

Polyesterschnur in 3 mm

Polyester rope in 3 mm

60063

Seilklemme für Polyesterschnur

Rope clamp for polyester rope

10069

Seilklemme mit Kronring, verbindet

Polyesterschnur zum Drahtseil

Rope clamp with metal ring, connects

polyester rope to metal cable

60060

Aufhängung kompletter Satz je Tränkeinheit 3 mtr., mit Seilrolle, Drahtseil, Schnur und Klammern

Suspension

complete set per drinker unit 3 mtr., with pulley, cable, rope and clamps

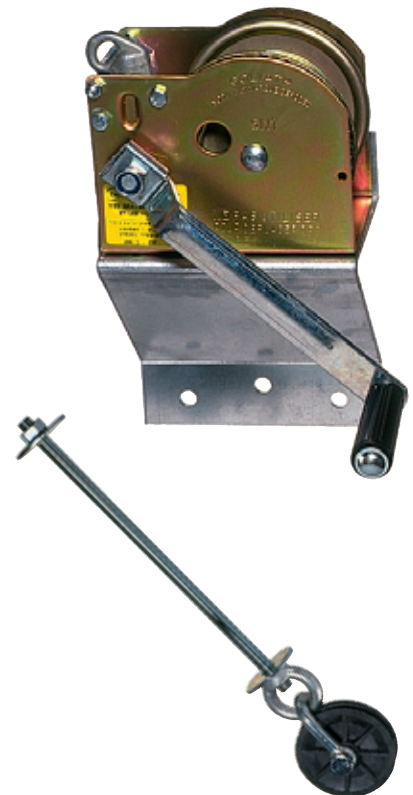

10065

Winden-Set inkl. Winde mit Bremse (550 KG), Konsole, Hauptlenkrolle mit Spindel und Zugseil 10 mtr.

Winch set incl. winch with brake (550 KG), mounting plate, main pulley with spindle and tug cable of 10 mtr.

10066-11

Winde einzeln, mit Bremse und 550 KG Zugkraft. GS geprüft

Winch alone, with brake and 550 KG capacity. GS tested



10061-10-1237

Tränkeneinheit

Länge 3 mtr., mit 10 St. Nippeltränke Nr. 10012 und Auffangschale Nr. 10037

Drinker unit

length 3 mtr., with 10 pcs. nippeldrinkers no. 10012 and drip-cups no. 10037

10061-12-1237

Tränkeneinheit

Länge 3 mtr., mit 12 St. Nippeltränke Nr. 10012 und Auffangschale Nr. 10037

Drinker unit

length 3 mtr., with 12 pcs. nippeldrinkers no. 10012 and drip-cups no. 10037

Tränkeneinheit

mit 22 mm Vierkantrrohr in Länge 3 mtr., für Broiler, Aufzucht und Elterntiere, vormontiert mit Nippeltränke Nr. 10012 und dazu Auffangschale Nr. 10037, jeweils 10 – 12 – 15 Stück je 3 mtr. inkl. komplettes Zubehör gem. Foto

Drinker unit

with 22 mm square pipe in length 3 mtr., for broiler, rearing and parent birds, pre-assembled with nippeldrinkers no. 10012 and also drip-cups no. 10037, always with 10 -12 -15 of each per 3 mtr. incl. complete accessories as on photo

10061-15-1237

Tränkeneinheit

Länge 3 mtr., mit 15 St. Nippeltränke Nr. 10012 und Auffangschale Nr. 10037

Drinker unit

length 3 mtr., with 15 pcs. nippeldrinkers no. 10012 and drip-cups no. 10037

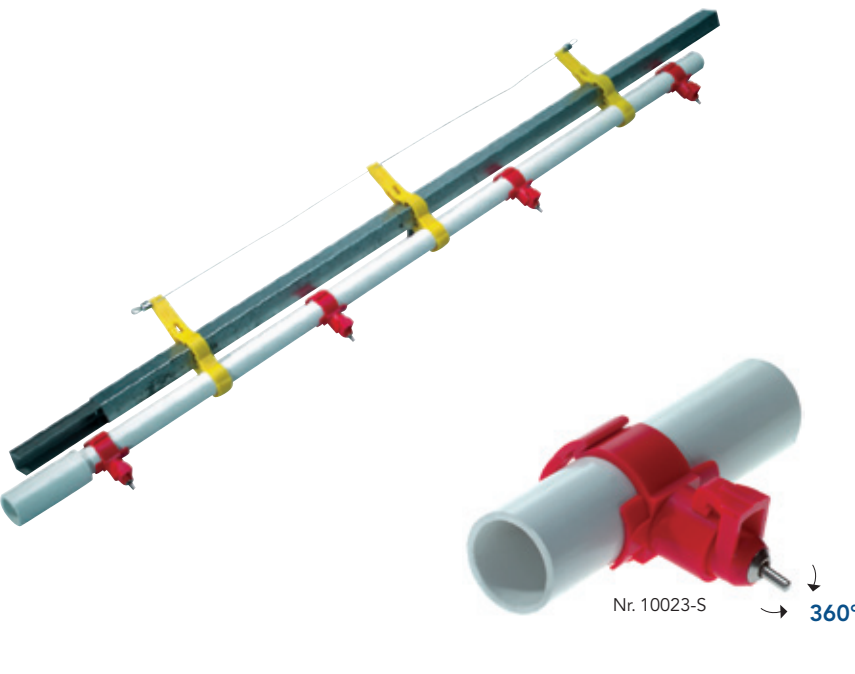

10062-12

Tränkeneinheit

Länge 3 mtr., mit 12 St. Monodrop Nippeltränken Nr. 10023-S

Drinker unit

length 3 mtr., with 12 pcs. Monodrop nippeldrinkers no. 10023-S

10062-15

Tränkeneinheit

Länge 3 mtr., mit 15 St. Monodrop Nippeltränken Nr. 10023-S

Drinker unit

length 3 mtr., with 15 pcs. Monodrop nippeldrinkers no. 10023-S

Tränkeneinheit

mit ¾" Rundrohr in Länge 3 mtr., für Broiler, Aufzucht und Elterntiere, vormontiert mit rundem Sattel und Monodrop Nippeltränke (Nr. 10023-S), jeweils 12 – 15 – 20 Stück je 3 mtr. inkl. kompletten Zubehör gem. Foto

Drinker unit

with ¾" round pipe in length 3 mtr., for broiler, rearing and parent birds, incl. pre-assembled with round saddle and Monodrop nippeldrinkers no. 10023-S, always with 12 -15 -20 of each per 3 mtr. incl. complete accessories as on photo

Ich komme ja auch nicht als halbes Hähkuchen zur Welt!



10062-20

Tränkeneinheit

Länge 3 mtr., mit 20 St. Monodrop Nippeltränken Nr. 10023-S

Drinker unit

length 3 mtr., with 20 pcs. Monodrop nippeldrinkers no. 10023-S



10040-1

Nippeltränke

mit Edelstahl-Klammer und 3/8" Tülle

Nippelrinker

with stainless steel clip and 3/8" barb



10040-2

Nippeltränke

mit Edelstahl-Schraubenhalter, 3/8" Tülle

Nippelrinker

with stainless steel screw bracket, 3/8" barb



Zubehör in 3/8"

Accessories in 3/8"

10040-7 Schlauch Tube

10040-3 T-Stück T-piece

10040-5 X-Stück X-piece

10040-6 Verbinder-Stück Connector-piece

10040-8 L-Stück L-piece

10040-9 Stopfen Plug



10040-0

Chinchilla Nippeltränke 1/8"

Edelstahl, mit Beißfunktion, kaum Wasserverluste

Chinchilla nippelrinker 1/8"

stainless steel, with bite function, minimal water spillage



10041-1

Nippeltränke 1/8"

Edelstahl, mit 6 cm Verlängerung

Nippelrinker 1/8"

stainless steel, with 6 cm extension

10041-1-1

Nur Verlängerung - only extension



10041-6 20

Hasenränke 1 Liter

Kunststoff Flasche mit Edelstahl Nippeltränke und 90° Winkel, sowie Deckel und Befestigungsklammer, sehr praktisch und passt an alle Käfige

Rabbitrinker 1 liter

plastic bottle with stainless steel nipple-drinker and 90° angle, as well as lid and fastening clip, very practical and fits on all cages



10041-7 20

Hasenränke 0.5 Liter

Kunststoff Flasche mit Edelstahl Nippeltränke und 90° Winkel, sowie Deckel und Befestigungsklammer, sehr praktisch und passt an alle Käfige

Rabbitrinker 0.5 liter

plastic bottle with stainless steel nipple-drinker and 90° angle, as well as lid and fastening clip, very practical and fits on all cages



10041-4

Nippeltränke 1/8"

Edelstahl, mit 90° Winkel

Nippelrinker 1/8"

stainless steel, with 90° angle

10041-4-1

Nur 90° Winkel - only 90° angle

Die bei Monoflo sind richtig alte Hasen.





Maße/Dimension

20070-50-60	50 x 60 cm
20070-60-60	60 x 60 cm
20070-60-70	60 x 70 cm
20070-70-70	70 x 70 cm
20070-70-80	70 x 80 cm
20070-80-80	80 x 80 cm

20070

Kotwanne

aus schlagfestem PE-Kunststoff, passend zu den gängigen Käfigen, viele verschiedene Maße vorrätig

Manure tray

from high-impact PE-material, fits to the common cages, many different sizes available

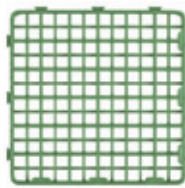

20071-25-25

Bodenplatten aus schlagfestem PE-Kunststoff, Maß 25 x 25 cm, in grün, passend zu den gängigen Käfigen, Sonderfarben ab 250 St.

Floor plates from high-impact PE-material, size 25 x 25 cm, in green, fits to the common cages, special colors from 250 pcs.



10047-6-B

Futternapf aus Kunststoff mit Edelstahl Beißkanten und Stange gegen Futterverluste

Feeding cup from plastic with stainless steel protection and bar against feed wastage



10047-8-B

Wandhalterung

mit Gegenplatte und Schrauben aus Kunststoff für alle Futternäpfe, erlaubt einfache und schnelle Montage

Back plate complete with screws, for all feed-cups, allows easy and fast installation

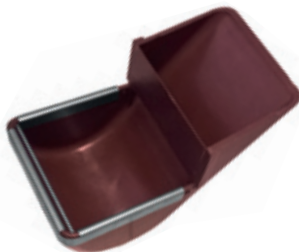

10047-7

Futternapf schwenkbar, aus Kunststoff mit Beißkanten aus Edelstahl, passend zu den gängigen Käfigen

Feeding cup with swivel, from plastic with stainless steel protection at edges, fits to the common cages



10045-6 50

Futternapf 500ml aus Edelstahl, für einfache Montage, Rückplatte 10047-8 verwenden

Feeding cup 500ml in stainless steel, for installation please use back-plate 10047-8



10045-7 50

Futternapf 300ml aus Edelstahl, für einfache Montage, Rückplatte 10047-8 verwenden

Feeding cup 500ml in stainless steel, for installation please use back-plate 10047-8



10042 24

Futterautomat

mit Beißkanten, Inhalt 1,8 KG

Automatic feeder

with protection at edges, cap. 1.8 KG

10042-1

Deckel - Lid



Tränkröhrchen aus Edelstahl, passend zu den gängigen Tränkflaschen

Drinker pipe in stainless steel, fits to the standard drink-bottles

10041-10 gerade straight

10041-11 gebogen bent



10049

Schussapparat

mit Schlagbolzen zum Betäuben der Kleintiere vor dem Schlachten

Bolting unit

the bolt makes small animal unconscious before slaughtering

MONOFLO[®]

Since 1962 | Further into a great Future

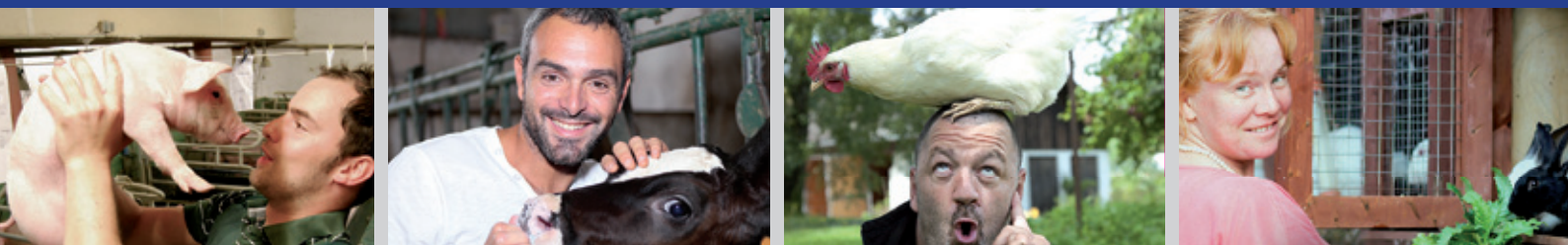

OPTI-COOL

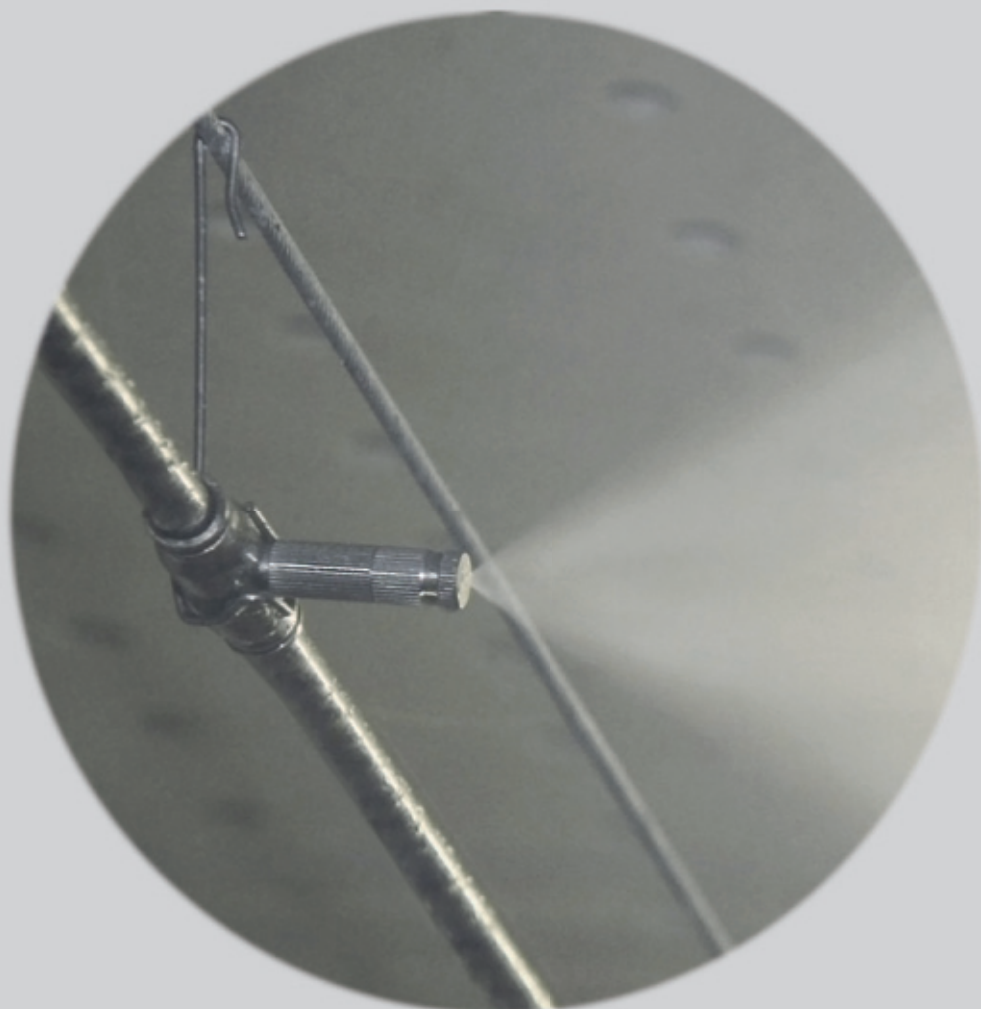

OPTI COOL das perfekte Kühlsystem mit Wasservernebelung von 70 bar.

Aufgrund der einfachen Montage und individuellen Steuerung ist der Einbau in vorhandene sowie wie neue Stallungen möglich. Wegen der intelligenten Regelsteuerung ist unser OPTI COOL System bei Einhaltung der maximalen Düsenanzahl beliebig erweiterbar.

Das System entspricht den hohen Anforderungen des Tierwohls und ist somit für die Zukunft der Tierhaltung gut gerüstet. Jedes Abteil erhält einen Feuchtigkeits- und Temperatursensor. Die OPTI COOL Steuerung kann dadurch jedes Abteil individuell regeln und somit die optimale Kühlleistung erreichen. Wie Sie von uns gewohnt sind, werden alle wichtigen Bauteile wie Düsen, Rohre, Verbinder etc., aus hochwertigem Edelstahl hergestellt.

OPTI COOL the perfect cooling system based on fogging of 70 bar pressure.

Due to the simple assembly and individual control, the installation is possible in existing as well as new buildings. Due to the intelligent control system, our OPTICOOL system can be expanded as required, while maintaining the maximum number of nozzles allowed.

The system meets the high requirements of animal welfare and is therefore well equipped for the future of animal husbandry. Each compartment is equipped with an humidity and temperature sensor. The OPTICOOL control system can thus individually control each room and thereby achieve the optimum cooling performance. As you are accustomed from us, all important components such as nozzles, pipes, connectors etc. are made of high-quality stainless steel.



40910-10

**Pumpeneinheit, 70 bar,
Leistung 0,5 – 10 ltr/min**

400 V / 50 Hz, frequenzgesteuert,
Maße 400 x 600 x 500 mm, für 10 bis
220 Düsen, inkl. Steuerung 40910-01

**Pump unit, 70 bar,
capacity 0,5 – 10 ltr/min**

400 V / 50 Hz, frequency controlled,
size 400 x 600 x 500 mm, for 10 to 220
nozzles, incl. controller No. 40910-01

40910-18

**Pumpeneinheit, 70 bar,
Leistung 1 – 18 ltr/min**

400 V / 50 Hz, frequenzgesteuert,
Maße 400 x 600 x 500 mm, für 20 bis
360 Düsen, inkl. Steuerung 40910-01

**Pump unit, 70 bar,
capacity 1 – 18 ltr/min**

400 V / 50 Hz, frequency controlled,
size 400 x 600 x 500 mm, for 20 to 360
nozzles, incl. controller No. 40910-01



40940

Filterereinheit ¾"

vier Filter in Reihe mit Rückspülung,
abgestuft in 80/20/5/1 micron

Filter unit ¾"

four filters in a row with flushing, in
steps of 80/20/5/1 micron



40950-500

Spezialschlauch, 70 bar, 5 m

zur Verbindung der Pumpe (1/2") mit
dem Rohrsystem (10 mm) im Gang

Special hose, 70 bar, 5 m

for connection of the pump (1/2") with
the pipe-system (10 mm) in the aisle

Monoflo has pig ideas.





40961-600

Rohr 10 x 1 mm

Länge 6 m zur Verlegung im Hauptgang

Pipe 10 x 1 mm

length 6 m for installation in the main aisle



40925

Verbinder 10 mm

Schraubverbindung für Rohr 10 mm mit Gewindeabgang zum Abteil

Connector 10 mm

screw connection for pipe 10 mm



40928

L-Verbinder 10 mm

Schraubverbindung für Rohr 10 mm

L-connector 10 mm

screw connection for pipe 10 mm



40922

Endstopfen 10 mm

Schraubverbindung für Rohr 10 mm

End plug 10 mm

screw connection for pipe 10 mm



40924

T-Verbinder 10 mm

Schraubverbindung für Rohr 10 mm mit Gewindeabgang zum Abteil

T-Connector 10 mm

screw connection for pipe 10 mm with thread outlet into the room



40938

Haltewinkel, 120 x 180 mm

zur Wandmontage der Rohre 10 mm

Bracket, 120 x 180 mm

for wall-installation of pipe 10 mm



40934

Rohrschelle, gummiert

Halterung für Rohre 10 mm

Pipe clamp, with rubber

clamp for pipe 10 mm



40911-55

Magnetventil 3/2 Wege, 70 bar

zum Öffnen/Schließen/Entlasten der Rohrleitung

Solenoid valve 3/2 way, 70 bar

allows opening/closing/relieve of pipeline



40929

Kugelhahn, 70 bar

zum Absperren der Rohrleitung zwischen T-Verbinder und Magnetventil

Ball valve, 70 bar

for shut-off of pipeline between T-connector and solenoid valve



40950-100

Spezialschlauch, 70 bar, 1 m

zur Verbindung vom Magnetventil ins Abteil

Special hose, 70 bar, 1 m











for connection from solenoid valve into the room



40942

Controller regelt unabhängig von der Lüftung individuell das Kühlen, Einweichen und Staubbinden in jedem Abteil, Einstellungen: Feuchtigkeit, Temperatur, Laufzeit, Pausenzeit, Kalibrierung der Parameter

Controller independently regulates the cooling, soaking and dust binding in each room, settings: humidity, temperature, running time, pause time, calibration of the parameters

	<p>40960-200 - 200 cm 40960-150 - 150 cm 40960-100 - 100 cm 40960-050 - 50 cm</p> <p>Rohr 9.5 x 1 mm mit Rille für das Stecksystem der Düsenverbinder</p> <p>Pipe 9.5 x 1 mm with groove for coupling system of the nozzle connectors</p>	 <p>40933</p> <p>Werkzeug schneidet Rille ins 9.5 mm Rohr</p> <p>Tool cuts groove into 9.5 mm pipe</p>
 <p>40904</p> <p>Edelstahl Düse 0,2 mm mit Sieb zum Vernebeln, Düseneinsatz aus Edelstahl</p> <p>St. steel nozzle 0.2 mm with screen for fogging, nozzle insert in st. steel</p>	 <p><i>Mit Monoflo hat man alles im Griff.</i></p>	 <p>40905</p> <p>Edelstahl Düse 0,2 mm mit Sieb zum Vernebeln, Düseneinsatz aus Keramik</p> <p>St. steel nozzle 0.2 mm with screen for fogging, nozzle insert in ceramic</p>
 <p>40912</p> <p>Verbinder 9.5 mm Stecksystem, mit Gewindeanschluss für eine Düse</p> <p>Connector 9.5 mm coupling system, with thread outlet for one nozzle</p>	 <p>40913</p> <p>Verbinder 9.5 mm Stecksystem, mit Gewindeanschlüsse für zwei Düsen</p> <p>Connector 9.5 mm coupling system, with thread outlets for two nozzles</p>	 <p>40918</p> <p>Endstück 9.5 mm Stecksystem, mit Gewindeanschluss für eine Düse</p> <p>End piece 9.5 mm coupling system, with thread outlet for one nozzle</p>
 <p>40916</p> <p>L-Verbinder Rohr 9.5 mm Stecksystem, 90°</p> <p>L-Connector pipe 9.5 mm coupling system, 90°</p>	 <p>40917</p> <p>T-Verbinder Rohr 9.5 mm Stecksystem</p> <p>T-Connector pipe 9.5 mm coupling system</p>	 <p>40920</p> <p>Verbinder Rohr 9.5 mm Stecksystem</p> <p>Connector pipe 9.5 mm coupling system</p>



40909

Düsenhalter mit Haken

zum Aufhängen des Rohrsystems mit Düsen

Nozzle holder with hook

for suspension of pipe system with nozzles



40932

Drahtseil, 4 mm

Edelstahl

Wire, 4 mm

stainless steel



40931

Wandplatte, Loch 12.5 mm

zur Befestigung des Drahtseils 4 mm, schwere Ausführung

Wall plate, hole 12.5 mm

for installation of wire 4 mm, heavy version



40935

Kausche

für Drahtseil 4 mm

Loop

for wire 4 mm



40936

Seilklemme

für Drahtseil 4 mm

Wire clamp

for wire 4 mm



1196-63

Wandplatte zur Befestigung des Drahtseils 4 mm, leichte Ausführung**Wall plate** for installation of wire 4 mm, light version

40937

Spannschluss M 10

für Drahtseil 4 mm

Snap-Lock M 10

for wire 4 mm



70060

Schlauchhalter

für Verbindungsschlauch Nr. 40950-100

Tube bracket

for connection hose no. 40950-100



40941

Feuchtigkeit und Temperatur Sensor

Amoniakbeständig, mit 2 m Kabel

Humidity and temperature sensor

ammoniac resistant, with 2 m cable

MONOFLO®

Since 1962 | Further into a great Future

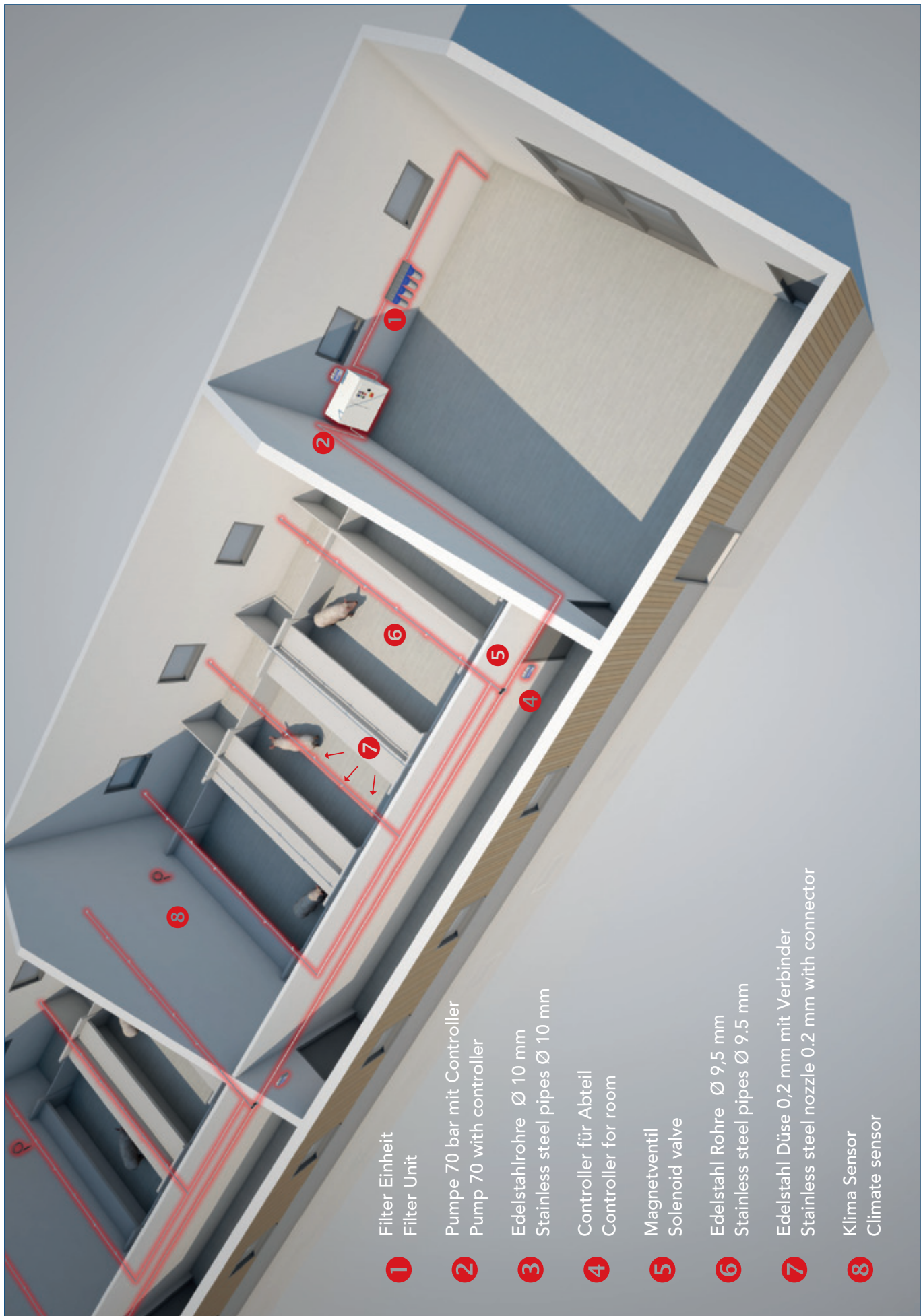

1 Filter Einheit
Filter Unit

2 Pumpe 70 bar mit Controller
Pump 70 with controller

3 Edelstahlrohre Ø 10 mm
Stainless steel pipes Ø 10 mm

4 Controller für Abteil
Controller for room

5 Magnetventil
Solenoid valve

6 Edelstahl Rohre Ø 9,5 mm
Stainless steel pipes Ø 9.5 mm

7 Edelstahl Düse 0,2 mm mit Verbinder
Stainless steel nozzle 0.2 mm with connector

8 Klima Sensor
Climate sensor



Since 1962 | Further into a great Future



Always expect more!

MONOFLO
Produktions GmbH & Co. KG

Lise-Meitner-Straße 16
64646 Heppenheim
Germany

Fon + 49 62 52 99 08 - 0
Fax + 49 62 52 99 08 - 28

www.monoflo.de
info@monoflo.de